



TRADE HOUSE



**MADE FOR
HARD WORK.**

2023

GARAGE SERVICE EQUIPMENT & REPAIR TOOLS



ASTON MARTIN ARAMCO COGNIZANT FORMULA ONE™ TEAM

AS A CONTINUATION OF JCB'S COMMITMENT TO BRITISH MOTORSPORT, IN 2023 JCB IS PROUD TO BE SPONSOR PARTNER OF THE ASTON MARTIN ARAMCO COGNIZANT FORMULA ONE™ TEAM



CONTENTS

ASTON MARTIN FORMULA ONE™ TEAM	2
THE STORY OF JCB	4
TROLLEY JACKS	6
BOTTLE JACK	19
JACK STANDS	32
POSITIONING JACKS	40
PORTABLE BODY REPAIR KIT	43
ENGINE STAND-CRANE	45
HYDRAULIC PRESSES	48
AIR TOOLS	55
LASER & LEVELERS.	68
SOCKETS	72
SPANNERS	77



THE STORY OF JCB

THE STORY OF JCB IS ONE OF INNOVATION, AMBITION AND SHEER HARD WORK.

From small beginnings building agricultural tipping trailers in 1945, to the global force in manufacturing the company has become today, JCB has constantly pushed the boundaries in our desire to be the best. My father and company founder Joseph Cyril Bamford's motto was, "Jamais content", and that is exactly right – we are never content with our achievements. But I believe that even he would be amazed by what the company has become. Today, we have 22 plants on four continents and more than 750 dealers around the world.

These are exciting times. In just 75 years we have gone from one man in a garage in Uttoxeter to major global brand renowned for its pioneering spirit. All of this is down to our people – a 11,000-strong worldwide force that makes up the JCB family we are so proud of. Our achievements over the past 75 years have been considerable, but at JCB we believe in always looking ahead to the next development, the next level of success. As we speak, JCB is continuing to innovate and push the boundaries in research and development; in particular within the area of sustainability, where energy costs and emissions are becoming an increasingly important purchasing consideration. Many of our customers will need to reinvent their businesses to meet new building standards and emissions legislation, and we will be there to support them every step of the way, as we have always been.

Do take the time to read through the innovation milestones over the decades on the timeline below.

Lord Bamford - Chairman



1949



A MAJOR INNOVATION

In a little less than three years since JCB started, launched Europe's first industrial front-end loader.

1985



BACKHOE BESTSELLER

In 1985 the 3CX Sitemaster backhoe loader was launched and went on to be JCB's biggest-ever selling backhoe.

2010



THE NEW ECO BACKHOE LOADER

JCB unveils its new fuel-cost cutting ECO backhoe loader. The first two machines in union jack colours to celebrate the company's 65th anniversary.

2020



100% ELECTRIC. ZERO EMISSIONS.

JCB's pioneering range of machines are 100% electric with zero emissions, zero compromise on performance and a lot less noise.

1964



JCB'S FIRST CRAWLER EXCAVATOR

was manufactured under licence from Warner Swasey and powered by a Ford engine, while JCB made the undercarriage and excavator assemblies.

2006



RECORD-BREAKING DIESELMAX

The JCB DIESELMAX streamliner was powered by two JCB 444 diesel engines producing an incredible 1500hp, achieved a record speed of 350.092mph on Bonneville Salt Flats in Utah, setting a new world land speed record for a diesel-powered car.

2019



WORLD'S FASTEST TRACTOR

The JCB WFT storms into the Guinness World Records book as the world's fastest tractor with a top speed of 153.771mph (247.470kph).

2023

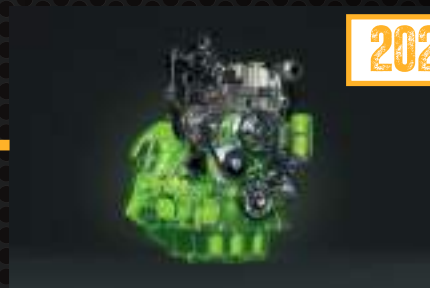

FUELLING THE FUTURE THROUGH INNOVATION

The 50th JCB hydrogen combustion engine came off the production line as part of the development process.

TROLLEY JACKS, MADE FOR HARD WORK.

TROLLEY JACKS

CRAFTED FROM HIGH-QUALITY MATERIALS AND ENGINEERED TO WITHSTAND THE TOUGHEST CONDITIONS, THESE TROLLEY JACKS ARE BUILT TO LAST. YOU CAN TRUST THEM TO PROVIDE YEARS OF DEPENDABLE SERVICE, MAKING THEM A WORTHWHILE INVESTMENT FOR YOUR GARAGE.

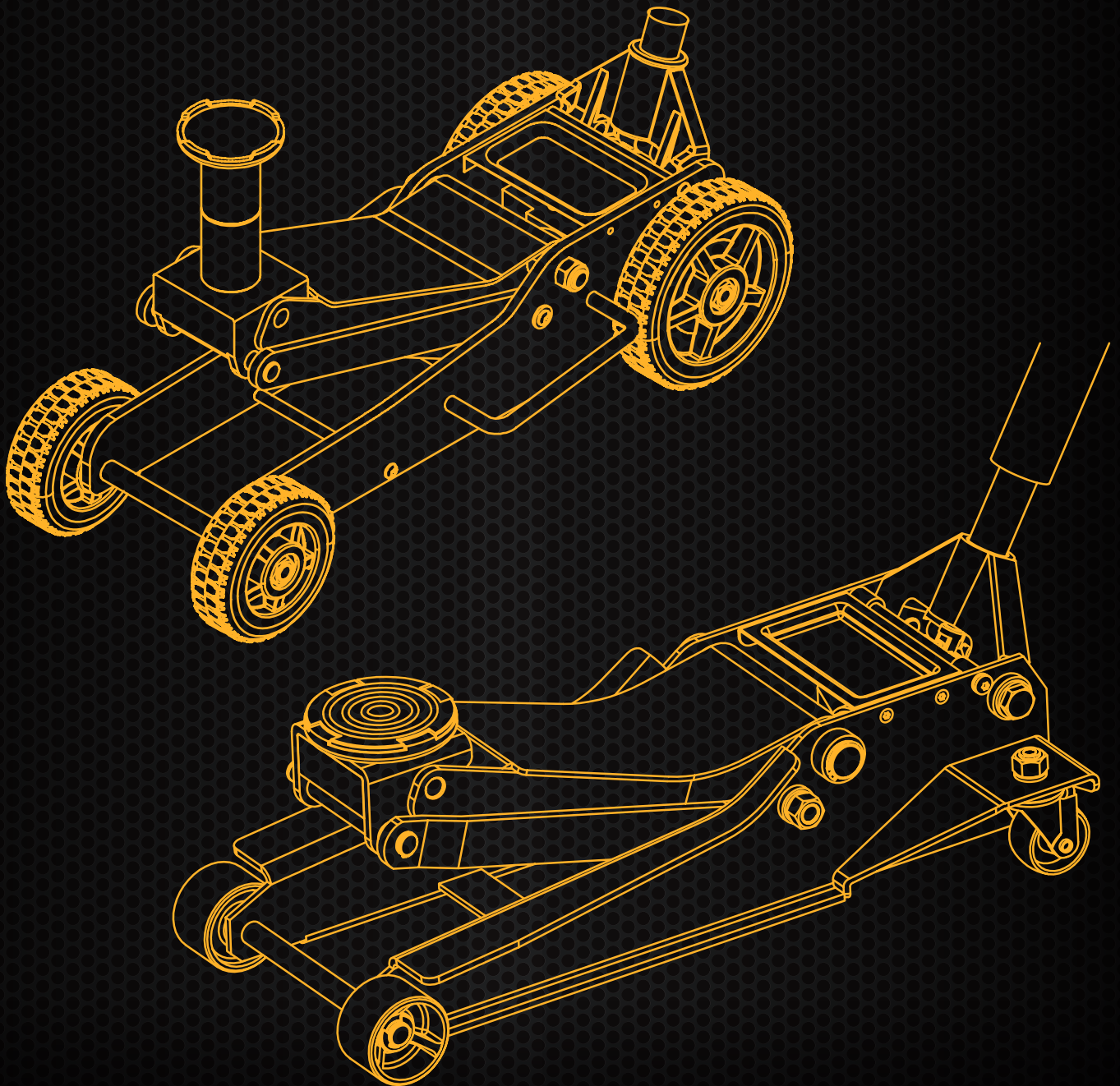

	T820050	TA82001	T82003	T825051	T825010R	T830020	T83006XB
							
MAX LOAD	2T	2T	2.5T	2.5T	2T	3T	2.5T
MIN HEIGHT	135MM	85MM	130MM	85MM	89MM	135MM	150MM
MAX HEIGHT	340MM	330MM	375MM	330MM	359MM	400MM	530MM
NET WEIGHT	8.7 KG	10.5 KG	11.8 KG	12.6KG	14.2 KG	16.4KG	19.3KG
GROSS WEIGHT	9.4 KG	11.5 KG	12.3 KG	13,6KG	15.2 KG	17KG	21 KG

	TH22504	TH31501	TH33007	TH32515	TH33013	TH32006	T83502
							
MAX LOAD	2.25T	1.5T	3T	2.5T	3T	2T	3.5T
MIN HEIGHT	150MM	80MM	133MM	75MM	75MM	70MM	145MM
MAX HEIGHT	530MM	355MM	465MM	505MM	505MM	610MM	500MM
NET WEIGHT	21.5KG	14.5 KG	30.7 KG	28.6 KG	35.2 KG	45.8 KG	37.2 KG
GROSS WEIGHT	23KG	16.2 KG	33.0 KG	30.4 KG	37.0 KG	48.0 KG	38.4 KG
REMARKS	LONG BODY	DOUBLE PUMP	DOUBLE PUMP	DOUBLE PUMP	DOUBLE PUMP	DOUBLE PUMP	FOOT PEDAL

	TZ830018	T83508D	TZ84007	T830028	TH32506S	TQ22001	TQ35001
							
MAX LOAD	2.5T	3T	4T	3T	2.5T	22T	35T
MIN HEIGHT	87MM	98MM	98MM	140MM	140MM	220MM	250MM
MAX HEIGHT	455MM	535MM	508MM	525MM	677MM (W/EXT)	435MM	495MM
NET WEIGHT	33 KG	43.3 KG	43.1 KG	51 KG	40 KG	45 KG	46 KG
GROSS WEIGHT	34.6 KG	45.1 KG	45.6 KG	53 KG		47 KG	48 KG
REMARKS	LOW PROFILE	DOUBLE PUMP	DOUBLE PUMP	LONG TROLLEY	SUV OFF-ROAD	HEAVY LOADING	HEAVY LOADING

2 TONNE LOW-PROFILE TROLLEY JACK

T820050



SPECIFICATION

MAX. LOAD	2T
MIN. HEIGHT	135MM
MAX. HEIGHT	340MM
NET WEIGHT	8.7 KG
GROSS WEIGHT	9.4 KG
PRODUCT SIZE	447X196X135MM
PACKAGE SIZE	460X215X145MM
20' CONTAINER	1.950 PIECE
BARCODE	5056485705027

FEATURES

- With protection rubber pad
- Swivel rear wheels provide smooth maneuvering and positioning
- Carry handle for convenient transportation
- Heavy-Duty steel construction provides stability and endurance



MAX. HEIGHT
340mm
MIN. HEIGHT
135mm



RUBBER
SADDLE PAD



EXTRA LOW
PROFILE DESIGN



SWIVEL REAR
WHEELS

2 TONNE LOW-PROFILE TROLLEY JACK

TA82001



SPECIFICATION

MAX. LOAD	2T
MIN. HEIGHT	85MM
MAX. HEIGHT	330MM
NET WEIGHT	10.5 KG
GROSS WEIGHT	11.5 KG
PRODUCT SIZE	534X216X135MM
PACKAGE SIZE	548X230X160MM
20' CONTAINER	1.450 PIECE
BARCODE	5056485705003

FEATURES

- With protection rubber pad
- Swivel rear wheels provide smooth maneuvering and positioning
- Carry handle for convenient transportation
- Heavy-Duty steel construction provides stability and endurance
- Extra low profile design



MAX. HEIGHT
330mm
MIN. HEIGHT
85mm



RUBBER
SADDLE PAD



EXTRA LOW
PROFILE DESIGN



SWIVEL REAR
WHEELS

2 TONNE TROLLEY JACK

T82003

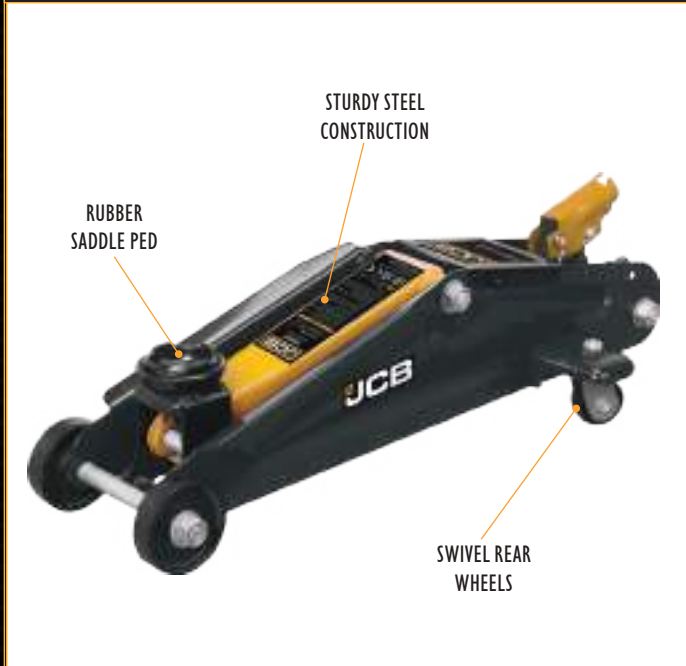

SPECIFICATION

MAX. LOAD	2.5T
MIN. HEIGHT	130MM
MAX. HEIGHT	375MM
NET WEIGHT	11.8 KG
GROSS WEIGHT	12.3 KG
PRODUCT SIZE	531X223X132MM
PACKAGE SIZE	555X250X160M
20' CONTAINER	1.288 PIECE
BARCODE	5056485705034

FEATURES

- With protection rubber pad
- Swivel rear wheels provide smooth maneuvering and positioning
- Heavy-Duty steel construction provides stability and endurance

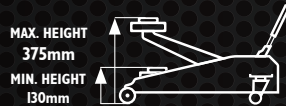

2 TONNE LOW-PROFILE TROLLEY JACK

T825051



SPECIFICATION

MAX. LOAD	2.5T
MIN. HEIGHT	85MM
MAX. HEIGHT	330MM
NET WEIGHT	12.6KG
GROSS WEIGHT	13.6KG
PRODUCT SIZE	569X214X130MM
PACKAGE SIZE	613X265X150MM
20' CONTAINER	1.008 PIECE
BARCODE	5056485705010

FEATURES

- With protection rubber pad
- Swivel rear wheels provide smooth maneuvering and positioning
- Carry handle for convenient transportation
- Heavy-Duty steel construction provides stability and endurance
- Extra low profile design



2 TONNE LOW-PROFILE TROLLEY JACK

T825010R



SPECIFICATION

MAX. LOAD	2T
MIN. HEIGHT	89MM
MAX. HEIGHT	359MM
NET WEIGHT	14.2 KG
GROSS WEIGHT	15.2 KG
PRODUCT SIZE	556X234X140MM
PACKAGE SIZE	610X275X160MM
20' CONTAINER	1.008 PIECE
BARCODE	5056485705027

FEATURES

- With protection rubber pad
- Swivel rear wheels provide smooth maneuvering and positioning
- Heavy-Duty steel construction provides stability and endurance
- Extra low profile design



MAX. HEIGHT
359mm
MIN. HEIGHT
89mm



RUBBER
SADDLE PAD



EXTRA LOW
PROFILE DESIGN



SWIVEL REAR
WHEELS

3 TONNE TROLLEY JACK

T830020



SPECIFICATION

MAX. LOAD	3T
MIN. HEIGHT	135MM
MAX. HEIGHT	400MM
NET WEIGHT	16.4KG
GROSS WEIGHT	17KG
PRODUCT SIZE	592X240X146MM
PACKAGE SIZE	630X280X165MM
20' CONTAINER	1.008 PIECE
BARCODE	5056485705041

FEATURES

- With protection rubber pad
- Swivel rear wheels provide smooth maneuvering and positioning
- Heavy-Duty steel construction provides stability and endurance



MAX. HEIGHT
400mm
MIN. HEIGHT
135mm



RUBBER
SADDLE PAD



SWIVEL REAR
WHEELS

2.5 TONNE QUICK-LIFT TROLLEY JACK

T83006XB



SPECIFICATION

MAX. LOAD	2.5T
MIN. HEIGHT	150MM
MAX. HEIGHT	530MM
NET WEIGHT	19.3KG
GROSS WEIGHT	21 KG
PRODUCT SIZE	625X242X158MM
PACKAGE SIZE	675X285X180MM
20' CONTAINER	768 PIECE
BARCODE	5056485705058

FEATURES

- With protection rubber pad
- Swivel rear wheels provide smooth maneuvering and positioning
- Heavy-Duty steel construction provides stability and endurance
- Extra long saddle



MAX. HEIGHT
530mm
MIN. HEIGHT
150mm



EXTRA
LONG SADDLE



RUBBER
SADDLE PAD



SWIVEL REAR
WHEELS

2.25 TONNE TROLLEY JACK

TH22504



SPECIFICATION

MAX. LOAD	2.25T
MIN. HEIGHT	150MM
MAX. HEIGHT	530MM
NET WEIGHT	21.5KG
GROSS WEIGHT	23KG
PRODUCT SIZE	720X255X180MM
PACKAGE SIZE	750X275X185MM
20' CONTAINER	740 PIECE
BARCODE	5056485704471

FEATURES

- With protection rubber pad
- Extra long body
- Extra height to use for SUVs
- Carry handle for convenient transportation
- Heavy-Duty steel construction provides stability and endurance
- Swivel rear wheels provide smooth maneuvering and positioning
- Swivel saddle provide smooth maneuvering and positioning
- Built-in safety valve protects against jack over-loading
- Hydraulic oil by-pass system protects ram from being over-extended
- Magnetic tray



MAX. HEIGHT
400mm
MIN. HEIGHT
135mm



RUBBER
PAD



EXTRA
LONG BODY



SWIVEL REAR
WHEELS



HANDLE
STORAGE



MAGNETIC
TRAY

1.5 TONNE LOW-PROFILE DOUBLE-PUMP ALUMINIUM JACK

TH31501



SPECIFICATION

MAX. LOAD	1.5T
MIN. HEIGHT	80MM
MAX. HEIGHT	355MM
NET WEIGHT	14.5 KG
GROSS WEIGHT	16.2 KG
PRODUCT SIZE	550X240X130MM
PACKAGE SIZE	595X280X165MM
20' CONTAINER	940 PIECE
BARCODE	5056485704402

FEATURES

- Double-Piston, Quick- Lift
- With rubber pad
- Heavy-Duty aluminium construction provides stability and endurance
- Side frame carry handle for convenient transportation
- Swivel rear wheels provide smooth maneuvering and positioning
- Swivel saddle provide smooth maneuvering and positioning
- Built-in safety valve protects against jack over-loading
- Hydraulic oil by-pass system protects ram from being over-extended



MAX. HEIGHT
355mm
MIN. HEIGHT
80mm



EXTRA LOW
PROFILE DESIGN



QUICK
LIFT



DUAL
PUMP



SWIVEL REAR
WHEELS

ALU/STEEL

ALUMINIUM / STEEL
CONSTRUCTION

3 TONNE DOUBLE-PUMP TROLLEY JACK

TH33007



SPECIFICATION

MAX. LOAD	3T
MIN. HEIGHT	133MM
MAX. HEIGHT	465MM
NET WEIGHT	30.7 KG
GROSS WEIGHT	33.0 KG
PRODUCT SIZE	682X344X155MM
PACKAGE SIZE	740X380X200MM
20' CONTAINER	470 PIECE
BARCODE	5056485704365

FEATURES

- Double-Piston, Quick- Lift
- With rubber pad
- Heavy-Duty steel construction provides stability and endurance
- Swivel rear wheels provide smooth maneuvering and positioning
- Swivel saddle provide smooth maneuvering and positioning
- Built-in safety valve protects against jack over-loading
- Hydraulic oil by-pass system protects ram from being over-extended



MAX. HEIGHT
465mm
MIN. HEIGHT
133mm



QUICK
LIFT



DUAL
PUMP



RUBBER
SADDLE PAD



SWIVEL REAR
WHEELS

2.5 TONNE LOW-PROFILE DOUBLE-PUMP TROLLEY JACK

TH32515

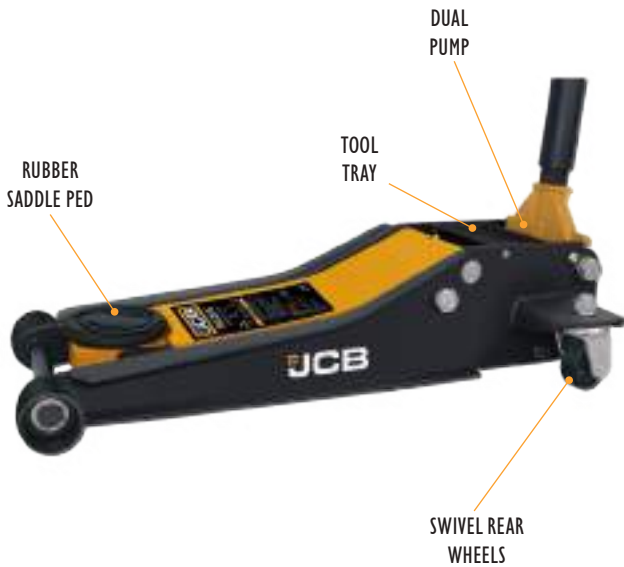

SPECIFICATION

MAX. LOAD	2.5T
MIN. HEIGHT	75MM
MAX. HEIGHT	505MM
NET WEIGHT	28.6 KG
GROSS WEIGHT	30.4 KG
PRODUCT SIZE	738X353X156MM
PACKAGE SIZE	805X370X205MM
20' CONTAINER	450 PIECE
BARCODE	5056485704372

FEATURES

- Double-Piston, Quick- Lift
- With rubber pad
- Extra Low-Profile Design
- Heavy-Duty steel construction provides stability and endurance
- Swivel rear wheels provide smooth maneuvering and positioning
- Swivel saddle provide smooth maneuvering and positioning
- Built-in safety valve protects against jack over-loading
- Hydraulic oil by-pass system protects ram from being over-extended



MAX. HEIGHT
505mm
MIN. HEIGHT
75mm



EXTRA LOW
PROFILE DESIGN



QUICK
LIFT



DUAL
PUMP



RUBBER
SADDLE PAD



SWIVEL REAR
WHEELS

3 TONNE LOW-PROFILE DOUBLE-PUMP TROLLEY JACK

TH33013

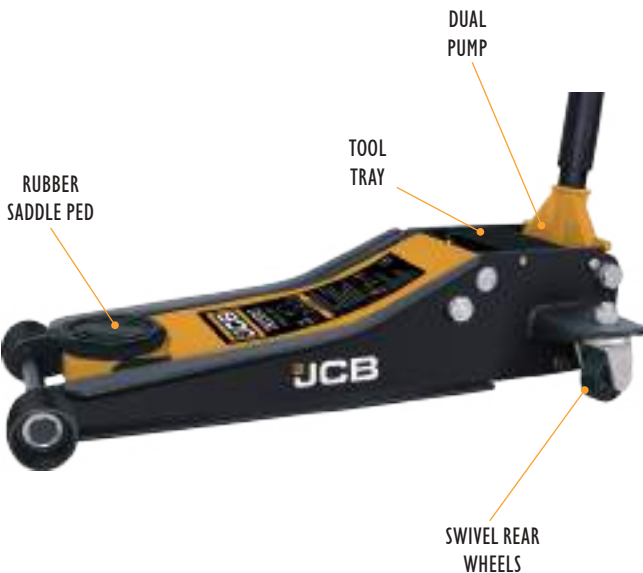

SPECIFICATION

MAX. LOAD	3T
MIN. HEIGHT	75MM
MAX. HEIGHT	505MM
NET WEIGHT	35.2 KG
GROSS WEIGHT	37.0 KG
PRODUCT SIZE	738X353X156MM
PACKAGE SIZE	805X370X205MM
20' CONTAINER	450 PIECE
BARCODE	5056485704372

FEATURES

- Double-Piston, Quick- Lift
- With rubber pad
- Heavy-Duty steel construction provides stability and endurance
- Swivel rear wheels provide smooth maneuvering and positioning
- Swivel saddle provide smooth maneuvering and positioning
- Built-in safety valve protects against jack over-loading
- Hydraulic oil by-pass system protects ram from being over-extended



MAX. HEIGHT
505mm
MIN. HEIGHT
75mm



EXTRA LOW
PROFILE DESIGN



QUICK
LIFT



DUAL
PUMP



RUBBER
SADDLE PAD



SWIVEL REAR
WHEELS

2 TONNE LOW-PROFILE DOUBLE-PUMP LONG JACK

TH32006



SPECIFICATION

MAX. LOAD	2T
MIN. HEIGHT	70MM
MAX. HEIGHT	610MM
NET WEIGHT	45.8 KG
GROSS WEIGHT	48.0 KG
PRODUCT SIZE	915X372X160MM
PACKAGE SIZE	960X410X210MM
20' CONTAINER	320 PIECE
BARCODE	5056485704471

FEATURES

- Double-Piston, Quick- Lift
- With rubber pad
- Heavy-Duty steel construction provides stability and endurance
- Swivel rear wheels provide smooth maneuvering and positioning
- Swivel saddle provide smooth maneuvering and positioning
- Built-in safety valve protects against jack over-loading
- Hydraulic oil by-pass system protects ram from being over-extended



MAX. HEIGHT
610mm
MIN. HEIGHT
70mm

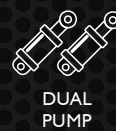

3.5 TONNE QUICK-LIFT TROLLEY JACK

T83502



SPECIFICATION

MAX. LOAD	3.5T
MIN. HEIGHT	145MM
MAX. HEIGHT	500MM
NET WEIGHT	37.2 KG
GROSS WEIGHT	38.4 KG
PRODUCT SIZE	685X346X180MM
PACKAGE SIZE	740X380X205MM
20' CONTAINER	495 PIECE
BARCODE	5056485705065

FEATURES

- With protection rubber pad
- Swivel rear wheels provide smooth maneuvering and positioning
- Heavy-Duty steel construction provides stability and endurance
- With quick stroke thanks to separate bypass pump (foot pedal)



MAX. HEIGHT
500mm
MIN. HEIGHT
145mm



2.5 TONNE LOW-PROFILE TROLLEY JACK

TZ830018



SPECIFICATION

MAX. LOAD	2.5T
MIN. HEIGHT	87MM
MAX. HEIGHT	455MM
NET WEIGHT	33 KG
GROSS WEIGHT	34.6 KG
PRODUCT SIZE	640X342X175MM
PACKAGE SIZE	700X390X215MM
20' CONTAINER	480 PIECE
BARCODE	5056485705072

FEATURES

- With protection rubber pad
- Swivel rear wheels provide smooth maneuvering and positioning
- Heavy-Duty steel construction provides stability and endurance
- Extra low profile design



MAX. HEIGHT
455mm
MIN. HEIGHT
87mm



EXTRA LOW
PROFILE DESIGN



RUBBER
SADDLE PAD



SWIVEL REAR
WHEELS

3 TONNE LOW-PROFILE DOUBLE-PUMP TROLLEY JACK

T83508D



SPECIFICATION

MAX. LOAD	3T
MIN. HEIGHT	98MM
MAX. HEIGHT	535MM
NET WEIGHT	43.3 KG
GROSS WEIGHT	45.1 KG
PRODUCT SIZE	750X345X170MM
PACKAGE SIZE	815X400X200MM
20' CONTAINER	385 PIECE
BARCODE	5056485705089

FEATURES

- With protection rubber pad
- Swivel rear wheels provide smooth maneuvering and positioning
- Heavy-Duty steel construction provides stability and endurance
- Extra low profile design
- Double-Piston, Quick- Lift



MAX. HEIGHT
535mm
MIN. HEIGHT
98mm



EXTRA LOW
PROFILE DESIGN



QUICK
LIFT



DUAL
PUMP



RUBBER
SADDLE PAD



SWIVEL REAR
WHEELS

4 TONNE TROLLEY JACK

TZ84007



SPECIFICATION

MAX. LOAD	4T
MIN. HEIGHT	98MM
MAX. HEIGHT	508MM
NET WEIGHT	43.1 KG
GROSS WEIGHT	45.6 KG
PRODUCT SIZE	726X342X170MM
PACKAGE SIZE	790X400X200MM
20' CONTAINER	385 PIECE
BARCODE	5056485705096

FEATURES

- With protection rubber pad
- Swivel rear wheels provide smooth maneuvering and positioning
- Heavy-Duty steel construction provides stability and endurance
- Extra low profile design
- Double-Piston, Quick-Lift



MAX. HEIGHT
508mm
MIN. HEIGHT
98mm

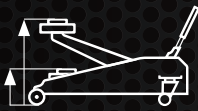

3 TONNE HEAVY-DUTY LONG TROLLEY JACK

T830028

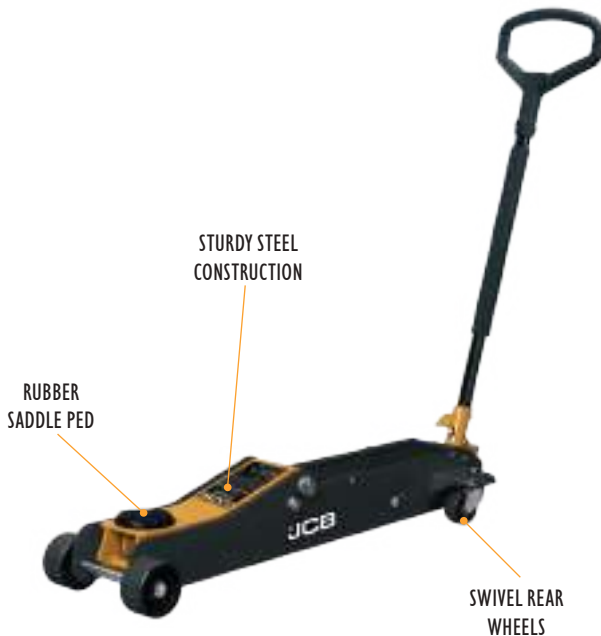

SPECIFICATION

MAX. LOAD	3T
MIN. HEIGHT	140MM
MAX. HEIGHT	525MM
NET WEIGHT	51 KG
GROSS WEIGHT	53 KG
RAM LIFT:	110MM
SCREW EXTEND	105MM
AIR PRESSURE	0.7-1.2MPA
PACKAGE SIZE	1280X410X240MM
20' CONTAINER	160 PIECE
BARCODE	5056485705102

FEATURES

- With protection rubber pad
- Swivel rear wheels provide smooth maneuvering and positioning
- Heavy-Duty steel construction provides stability and endurance



MAX. HEIGHT
525mm
MIN. HEIGHT
140mm



2.5 TONNE SUV ALUMINIUM TROLLEY JACK

TH32506S

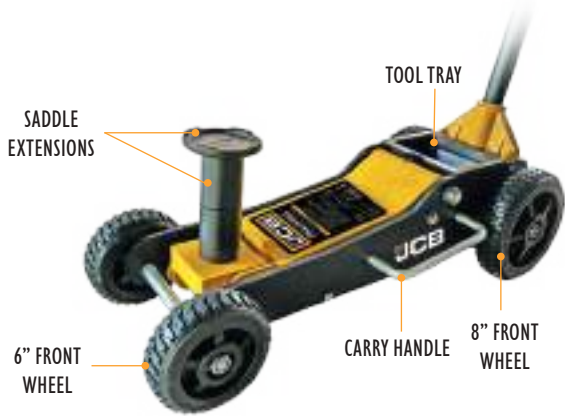

SPECIFICATION

MAX. LOAD	2.5T
MIN. HEIGHT	140MM
MAX. HEIGHT	525MM
MIN. HEIGHT WITH EXTENSION	292MM
MAX. HEIGHT WITH EXTENSION	677MM
WEIGHT	40KG
BARCODE	5056485705447

FEATURES

- Aluminium construction
- Off road wheels
- Dual pump
- 2x Saddle extension

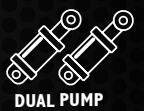

22 TONNE AIR TROLLEY JACK

TQ22001



SPECIFICATION

MAX. LOAD	22T
MIN. HEIGHT	220MM
MAX. HEIGHT	435MM
NET WEIGHT	45 KG
GROSS WEIGHT	47 KG
RAM LIFT:	110MM
SCREW EXTEND	105MM
AIR PRESSURE	0.7-1.2MPA
PACKAGE SIZE	675X390X260MM
20' CONTAINER	352 PIECE
BARCODE	5056485705119

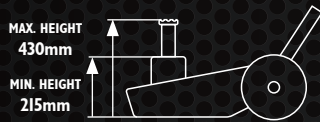

OVERSIZED RUBBER WHEELS

3X SADDLE EXTENSION ADAPTER

35 TONNE AIR TROLLEY JACK

TQ35001



SPECIFICATION

MAX. LOAD	35T
MIN. HEIGHT	250MM
MAX. HEIGHT	495MM
NET WEIGHT	46 KG
GROSS WEIGHT	48 KG
RAM LIFT:	130MM
SCREW EXTEND	115MM
AIR PRESSURE	0.7-1.2MPA
PACKAGE SIZE	675X390X260MM
20' CONTAINER	350 PIECE
BARCODE	5056485705126

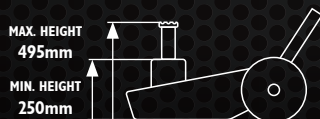

OVERSIZED RUBBER WHEELS

3X SADDLE EXTENSION ADAPTER

BOTTLE JACK

DESIGNED FOR HEAVY-DUTY LIFTING, THESE JACKS ARE THE EMBODIMENT OF JCB'S COMMITMENT TO INNOVATION AND QUALITY. EACH JACK IS ENGINEERED WITH HIGH-GRADE STEEL AND A ROBUST DESIGN TO WITHSTAND RIGOROUS USE, OFFERING A HIGH LIFTING CAPACITY THAT CAN HANDLE EVEN THE HEAVIEST LOADS WITH EASE WHETHER YOU'RE IN CONSTRUCTION, FARMING, OR AUTOMOTIVE INDUSTRIES.

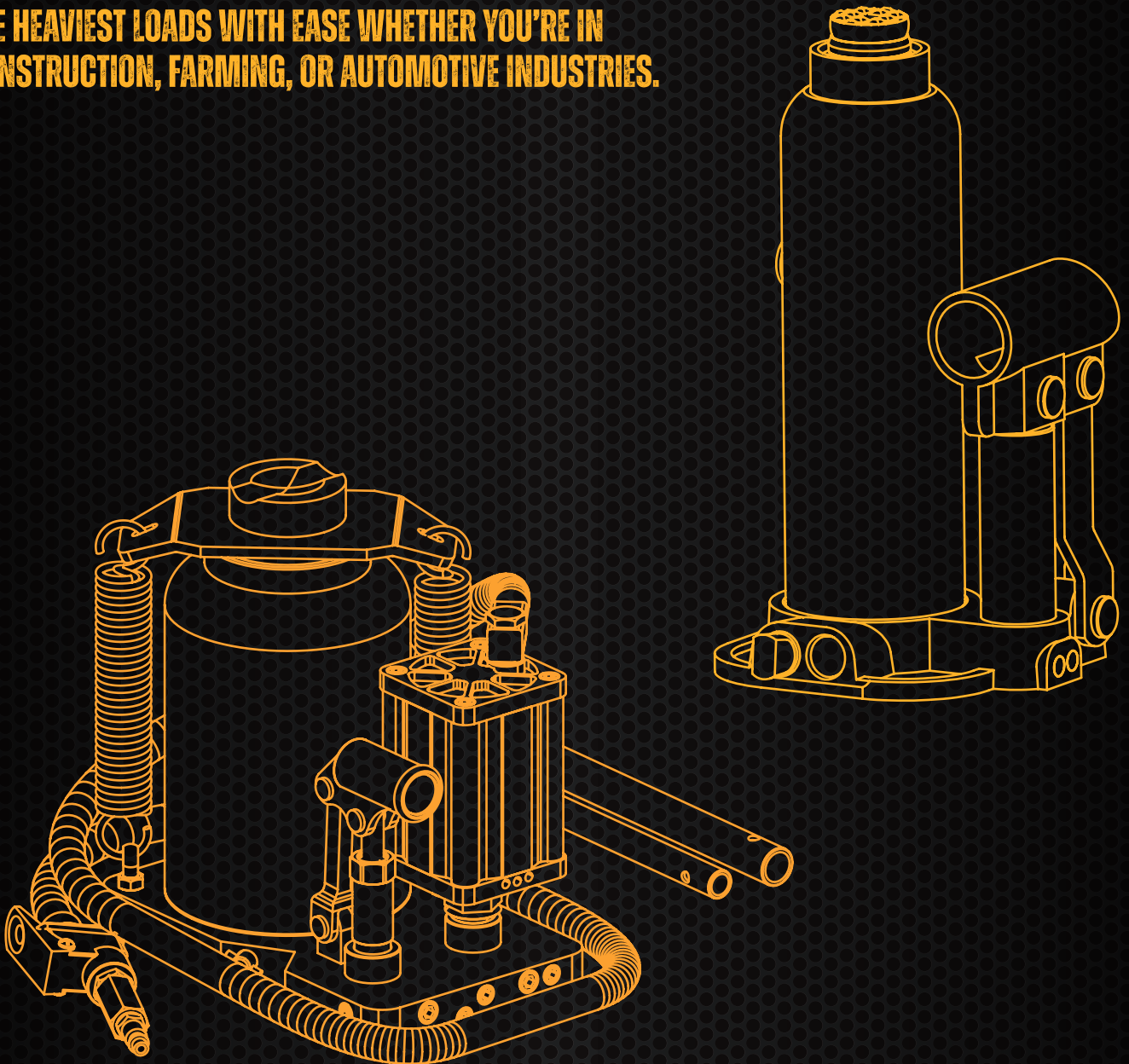

BOTTLE JACKS, MADE FOR HARD WORK.

	TH90204	TH90304	TH90504	TH90804	TH91004	TH91204	TH91504
							
MAX LOAD	2T	3T	5T	8T	10T	12T	15T
MIN HEIGHT	100MM	188MM	207MM	222MM	220MM	230MM	230MM
MAX HEIGHT	316MM	363MM	402MM	447MM	450MM	460MM	460MM
NET WEIGHT	2.0 KG	2.8 KG	3.7 KG	4.8 KG	4.8 KG	6.0 KG	7.0 KG
GROSS WEIGHT	2.1 KG	2.97 KG	3.92 KG	4.94 KG	4.94 KG	6.18 KG	7.13 KG

	TH92004	TH93204	TH95004	TH90200I	TH90350I	TH90500I	TH90800I
							
MAX LOAD	20T	32T	50T	2T	3.5T	5T	8T
MIN HEIGHT	240MM	260MM	280MM	172MM	172MM	218MM	220MM
MAX HEIGHT	450MM	420MM	450MM	372MM	372MM	474MM	488MM
NET WEIGHT	8.6 KG	17.8 KG	25.8 KG	3.79 KG	3.79 KG	4.89 KG	7.37 KG
GROSS WEIGHT	9.0 KG	18.5 KG	26.05 KG	3.95 KG	3.95 KG	5.05 KG	7.56 KG
REMARKS				HEAVY DUTY	HEAVY DUTY	HEAVY DUTY	HEAVY DUTY

	TH91000I	TH91500I	TH92000I	TH93000I	TQ12007	TQ20007	TQ30007
							
MAX LOAD	10T	15T	20T	30T	12T	20T	30T
MIN HEIGHT	220MM	280MM	241MM	244MM	260MM	255MM	265MM
MAX HEIGHT	488MM	508MM	525MM	510MM	500MM	500MM	500MM
NET WEIGHT	7.37 KG	9.87 KG	13.07 KG	15.77 KG	12 KG	17 KG	22 KG
GROSS WEIGHT	7.56 KG	10.12 KG	13.32 KG	16.11 KG	13 KG	18 KG	23.5 KG
REMARKS	HEAVY DUTY	HEAVY DUTY	HEAVY DUTY	HEAVY DUTY	PNEUMATIC	PNEUMATIC	PNEUMATIC

2 TONNE BOTTLE JACK

TH90204



SPECIFICATION

MAX. LOAD	2T
MIN. HEIGHT (A)	100MM
MAX. HEIGHT (D)	316MM
LIFT HEIGHT (B)	108MM
ADJUSTABLE HEIGHT (C)	48MM
NET WEIGHT	2.0 KG
GROSS WEIGHT	2.1 KG
PRODUCT SIZE	168X108X48MM
PACKAGE SIZE	340X235X205MM
20' CONTAINER	9.228 PIECE
BARCODE	5056485704785

FEATURES

- Steel plate instead of cast iron for environment protection
- Preventing from oil leakage
- Oil remaining clear after using



3 TONNE BOTTLE JACK

TH90304



SPECIFICATION

MAX. LOAD	3T
MIN. HEIGHT (A)	188MM
MAX. HEIGHT (D)	363MM
LIFT HEIGHT (B)	115MM
ADJUSTABLE HEIGHT (C)	60MM
NET WEIGHT	2.8 KG
GROSS WEIGHT	2.97 KG
PRODUCT SIZE	188X115X60MM
PACKAGE SIZE	375X265X225MM
20' CONTAINER	6.150 PIECE
BARCODE	5056485704792

FEATURES

- Steel plate instead of cast iron for environment protection
- Preventing from oil leakage
- Oil remaining clear after using



5 TONNE BOTTLE JACK

TH90504



SPECIFICATION

MAX. LOAD	5T
MIN. HEIGHT (A)	207MM
MAX. HEIGHT (D)	402MM
LIFT HEIGHT (B)	125MM
ADJUSTABLE HEIGHT (C)	70MM
NET WEIGHT	3.7 KG
GROSS WEIGHT	3.92 KG
PRODUCT SIZE	207X125X70MM
PACKAGE SIZE	280X265X25
20' CONTAINER	4.920 PIECE
BARCODE	5056485704808

FEATURES

- Steel plate instead of cast iron for environment protection
- Preventing from oil leakage
- Oil remaining clear after using



8 TONNE BOTTLE JACK

TH90804



SPECIFICATION

MAX. LOAD	8T
MIN. HEIGHT (A)	222MM
MAX. HEIGHT (D)	447MM
LIFT HEIGHT (B)	145MM
ADJUSTABLE HEIGHT (C)	80MM
NET WEIGHT	4.8 KG
GROSS WEIGHT	4.94 KG
PRODUCT SIZE	222X145X80MM
PACKAGE SIZE	295X275X260MM
20' CONTAINER	3.960 PIECE
BARCODE	5056485704815

FEATURES

- Steel plate instead of cast iron for environment protection
- Preventing from oil leakage
- Oil remaining clear after using



10 TONNE BOTTLE JACK

TH91004



SPECIFICATION

MAX. LOAD	10T
MIN. HEIGHT (A)	222MM
MAX. HEIGHT (D)	450MM
LIFT HEIGHT (B)	145MM
ADJUSTABLE HEIGHT (C)	80MM
NET WEIGHT	4.8 KG
GROSS WEIGHT	4.94 KG
PRODUCT SIZE	222X145X80MM
PACKAGE SIZE	295X275X260MM
20' CONTAINER	3.960 PIECE
BARCODE	5056485704822

FEATURES

- Steel plate instead of cast iron for environment protection
- Preventing from oil leakage
- Oil remaining clear after using



12 TONNE BOTTLE JACK

TH91204



SPECIFICATION

MAX. LOAD	12T
MIN. HEIGHT (A)	230MM
MAX. HEIGHT (D)	460MM
LIFT HEIGHT (B)	150MM
ADJUSTABLE HEIGHT (C)	80MM
NET WEIGHT	6.0KG
GROSS WEIGHT	6.18 KG
PRODUCT SIZE	230X150X80MM
PACKAGE SIZE	415X165X265MM
20' CONTAINER	3.256 PIECE
BARCODE	5056485704839

FEATURES

- Steel plate instead of cast iron for environment protection
- Preventing from oil leakage
- Oil remaining clear after using



15 TONNE BOTTLE JACK

TH91504



SPECIFICATION

MAX. LOAD	15T
MIN. HEIGHT (A)	230MM
MAX. HEIGHT (D)	460MM
LIFT HEIGHT (B)	150MM
ADJUSTABLE HEIGHT (C)	80MM
NET WEIGHT	7.0KG
GROSS WEIGHT	7.13 KG
PRODUCT SIZE	230X150X80MM
PACKAGE SIZE	300X180X270MM
20' CONTAINER	2.738 PIECE
BARCODE	5056485704846

FEATURES

- Steel plate instead of cast iron for environment protection
- Preventing from oil leakage
- Oil remaining clear after using



20 TONNE BOTTLE JACK

TH92004



SPECIFICATION

MAX. LOAD	20T
MIN. HEIGHT (A)	240MM
MAX. HEIGHT (D)	450MM
LIFT HEIGHT (B)	150MM
ADJUSTABLE HEIGHT (C)	60MM
NET WEIGHT	8.6 KG
GROSS WEIGHT	9.0 KG
PRODUCT SIZE	240X150X60MM
PACKAGE SIZE	315X185X275MM
20' CONTAINER	2.172 PIECE
BARCODE	5056485704853

FEATURES

- Steel plate instead of cast iron for environment protection
- Preventing from oil leakage
- Oil remaining clear after using



32 TONNE BOTTLE JACK

TH93204



SPECIFICATION

MAX. LOAD	32T
MIN. HEIGHT (A)	260MM
MAX. HEIGHT (D)	420MM
LIFT HEIGHT (B)	160MM
ADJUSTABLE HEIGHT (C)	MM (-")
NET WEIGHT	17.8 KG
GROSS WEIGHT	18.5 KG
PRODUCT SIZE	260X160X -MM
PACKAGE SIZE	220X200X300MM
20' CONTAINER	1.086 PIECE
BARCODE	5056485704860

FEATURES

- Steel plate instead of cast iron for environment protection
- Preventing from oil leakage
- Oil remaining clear after using



50 TONNE BOTTLE JACK

TH95004



SPECIFICATION

MAX. LOAD	50T
MIN. HEIGHT (A)	280MM
MAX. HEIGHT (D)	450MM
LIFT HEIGHT (B)	170MM
ADJUSTABLE HEIGHT (C)	- MM (-")
NET WEIGHT	25.8 KG
GROSS WEIGHT	26.05 KG
PRODUCT SIZE	280X170X -MM
PACKAGE SIZE	240X220X315MM
20' CONTAINER	757 PIECE
BARCODE	5056485704877

FEATURES

- Steel plate instead of cast iron for environment protection
- Preventing from oil leakage
- Oil remaining clear after using



2 TONNE HEAVY-DUTY BOTTLE JACK

TH902001



SPECIFICATION

MAX. LOAD	2T
MIN. HEIGHT (A)	172MM
MAX. HEIGHT (D)	372MM
LENGTH (B)	88MM
LENGTH (C)	112 MM
WIDTH (E)	28MM
BASE (F)	103X105MM
NET WEIGHT	3.79 KG
GROSS WEIGHT	3.95 KG
PACKAGE SIZE	375X290X225MM
20' CONTAINER	4.248 PIECE
BARCODE	5056485704884

FEATURES

- Zinc plated long handle allows ease of pumping.
- Welded construction NO LEAK.
- Safety valve prevents the ram from being overextended and causing damage to the cylinder.
- Inner safety valve prevent the user to adjust the system.
- Prevent rust with ENP (electroless nickel plating) ram piston, make it smooth, bright & long life.
- Double seals in the pump to prevent the oil leak.
- Light Weight forged base provides more steel only where strength is required.
- Better, stronger design with the tank welded directly to the forged base.
- Longer life than normal screw connection jack due to smooth bearing surfaces and close tolerances.
- Carrying handles on big capacity jack for easy transport.

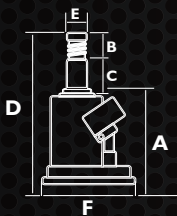

3.5 TONNE HEAVY-DUTY BOTTLE JACK

TH903501



SPECIFICATION

MAX. LOAD	3.5T
MIN. HEIGHT (A)	172MM
MAX. HEIGHT (D)	372MM
LENGTH (B)	88MM
LENGTH (C)	112 MM
WIDTH (E)	28MM
BASE (F)	103X105MM
NET WEIGHT	3.79 KG
GROSS WEIGHT	3.95 KG
PACKAGE SIZE	75X290X225MM
20' CONTAINER	4.248 PIECE
BARCODE	5056485704891

FEATURES

- Zinc plated long handle allows ease of pumping.
- Welded construction NO LEAK.
- Safety valve prevents the ram from being overextended and causing damage to the cylinder.
- Inner safety valve prevent the user to adjust the system.
- Prevent rust with ENP (electroless nickel plating) ram piston, make it smooth, bright & long life.
- Double seals in the pump to prevent the oil leak.
- Light Weight forged base provides more steel only where strength is required.
- Better, stronger design with the tank welded directly to the forged base.
- Longer life than normal screw connection jack due to smooth bearing surfaces and close tolerances.
- Carrying handles on big capacity jack for easy transport.

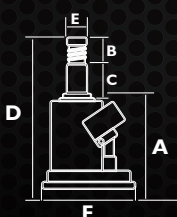

5 TONNE HEAVY-DUTY BOTTLE JACK

TH905001



SPECIFICATION

MAX. LOAD	5T
MIN. HEIGHT (A)	218MM
MAX. HEIGHT (D)	474MM
LENGTH (B)	110MM
LENGTH (C)	146MM
WIDTH (E)	32MM
BASE (F)	10X112MM
NET WEIGHT	4.89 KG
GROSS WEIGHT	5.05 KG
PACKAGE SIZE	405X300X260MM
20' CONTAINER	3.324 PIECE
BARCODE	5056485704884

FEATURES

- Zinc plated long handle allows ease of pumping.
- Welded construction NO LEAK.
- Safety valve prevents the ram from being overextended and causing damage to the cylinder.
- Inner safety valve prevent the user to adjust the system.
- Prevent rust with ENP (electroless nickel plating) ram piston, make it smooth, bright & long life.
- Double seals in the pump to prevent the oil leak.
- Light Weight forged base provides more steel only where strength is required.
- Better, stronger design with the tank welded directly to the forged base.
- Longer life than normal screw connection jack due to smooth bearing surfaces and close tolerances.
- Carrying handles on big capacity jack for easy transport.

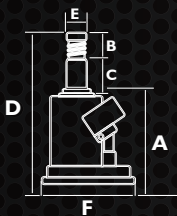

8 TONNE HEAVY-DUTY BOTTLE JACK

TH908001



SPECIFICATION

MAX. LOAD	8T
MIN. HEIGHT (A)	220MM
MAX. HEIGHT (D)	488MM
LENGTH (B)	115MM
LENGTH (C)	153MM
WIDTH (E)	48MM
BASE (F)	124X127.5MM
NET WEIGHT	7.37 KG
GROSS WEIGHT	7.56 KG
PACKAGE SIZE	755X185X270MM
20' CONTAINER	2.220 PIECE
BARCODE	5056485704914

FEATURES

- Zinc plated long handle allows ease of pumping.
- Welded construction NO LEAK.
- Safety valve prevents the ram from being overextended and causing damage to the cylinder.
- Inner safety valve prevent the user to adjust the system.
- Prevent rust with ENP (electroless nickel plating) ram piston, make it smooth, bright & long life.
- Double seals in the pump to prevent the oil leak.
- Light Weight forged base provides more steel only where strength is required.
- Better, stronger design with the tank welded directly to the forged base.
- Longer life than normal screw connection jack due to smooth bearing surfaces and close tolerances.
- Carrying handles on big capacity jack for easy transport.

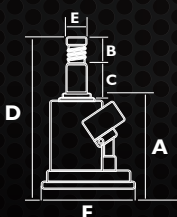

10 TONNE HEAVY-DUTY BOTTLE JACK

TH910001



SPECIFICATION

MAX. LOAD	10T
MIN. HEIGHT (A)	220MM
MAX. HEIGHT (D)	488MM
LENGTH (B)	115MM
LENGTH (C)	153MM
WIDTH (E)	48MM
BASE (F)	124X127.5MM
NET WEIGHT	7.37 KG
GROSS WEIGHT	7.56 KG
PACKAGE SIZE	755X185X270MM
20' CONTAINER	2.220 PIECE
BARCODE	5056485704921

FEATURES

- Zinc plated long handle allows ease of pumping.
- Welded construction NO LEAK.
- Safety valve prevents the ram from being overextended and causing damage to the cylinder.
- Inner safety valve prevent the user to adjust the system.
- Prevent rust with ENP (electroless nickel plating) ram piston, make it smooth, bright & long life.
- Double seals in the pump to prevent the oil leak.
- Light Weight forged base provides more steel only where strength is required.
- Better, stronger design with the tank welded directly to the forged base.
- Longer life than normal screw connection jack due to smooth bearing surfaces and close tolerances.
- Carrying handles on big capacity jack for easy transport.

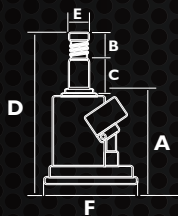

15 TONNE HEAVY-DUTY BOTTLE JACK

TH915001



SPECIFICATION

MAX. LOAD	15T
MIN. HEIGHT (A)	280MM
MAX. HEIGHT (D)	508MM
LENGTH (B)	113MM
LENGTH (C)	160MM
WIDTH (E)	58MM
BASE (F)	140X142MM
NET WEIGHT	9.87 KG
GROSS WEIGHT	10.12 KG
PACKAGE SIZE	790X190X575MM
20' CONTAINER	1.660 PIECE
BARCODE	5056485704938

FEATURES

- Zinc plated long handle allows ease of pumping.
- Welded construction NO LEAK.
- Safety valve prevents the ram from being overextended and causing damage to the cylinder.
- Inner safety valve prevent the user to adjust the system.
- Prevent rust with ENP (electroless nickel plating) ram piston, make it smooth, bright & long life.
- Double seals in the pump to prevent the oil leak.
- Light Weight forged base provides more steel only where strength is required.
- Better, stronger design with the tank welded directly to the forged base.
- Longer life than normal screw connection jack due to smooth bearing surfaces and close tolerances.
- Carrying handles on big capacity jack for easy transport.

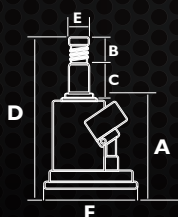

20 TONNE HEAVY-DUTY BOTTLE JACK

TH920001



SPECIFICATION

MAX. LOAD	20T
MIN. HEIGHT (A)	240MM
MAX. HEIGHT (D)	515MM
LENGTH (B)	110MM
LENGTH (C)	165MM
WIDTH (E)	60MM
BASE (F)	165X161MM
NET WEIGHT	13.07 KG
GROSS WEIGHT	13.32 KG
PACKAGE SIZE	710X205X290MM
20' CONTAINER	1.260 PIECE
BARCODE	5056485704945

FEATURES

- Zinc plated long handle allows ease of pumping.
- Welded construction NO LEAK.
- Safety valve prevents the ram from being overextended and causing damage to the cylinder.
- Inner safety valve prevent the user to adjust the system.
- Prevent rust with ENP (electroless nickel plating) ram piston, make it smooth, bright & long life.
- Double seals in the pump to prevent the oil leak.
- Light Weight forged base provides more steel only where strength is required.
- Better, stronger design with the tank welded directly to the forged base.
- Longer life than normal screw connection jack due to smooth bearing surfaces and close tolerances.
- Carrying handles on big capacity jack for easy transport.

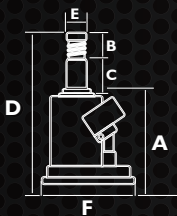

30 TONNE HEAVY-DUTY BOTTLE JACK

TH930001



SPECIFICATION

MAX. LOAD	30T
MIN. HEIGHT (A)	244MM
MAX. HEIGHT (D)	510MM
LENGTH (B)	110MM
LENGTH (C)	160MM
WIDTH (E)	65MM
BASE (F)	186X174MM
NET WEIGHT	15.77 KG
GROSS WEIGHT	16.11 KG
PACKAGE SIZE	585X215X285MM
20' CONTAINER	1.041 PIECE
BARCODE	5056485704945

FEATURES

- Zinc plated long handle allows ease of pumping.
- Welded construction NO LEAK.
- Safety valve prevents the ram from being overextended and causing damage to the cylinder.
- Inner safety valve prevent the user to adjust the system.
- Prevent rust with ENP (electroless nickel plating) ram piston, make it smooth, bright & long life.
- Double seals in the pump to prevent the oil leak.
- Light Weight forged base provides more steel only where strength is required.
- Better, stronger design with the tank welded directly to the forged base.
- Longer life than normal screw connection jack due to smooth bearing surfaces and close tolerances.
- Carrying handles on big capacity jack for easy transport.

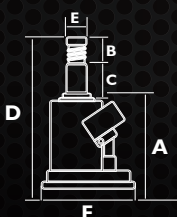

12 TONNE AIR BOTTLE JACK

TQ12007



SPECIFICATION

MAX. LOAD	12T
MIN. HEIGHT	260MM
MAX. HEIGHT	500MM
ADJUSTABLE HEIGHT	80MM
NET WEIGHT	12 KG
GROSS WEIGHT	13 KG
PACKAGE SIZE	280X170X295MM
20' CONTAINER	1.290 PIECE
BARCODE	5056485704969

FEATURES

- Chrome plated cylinder ram.
- High quality aluminium air pump.
- Welded construction.

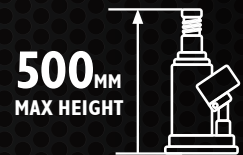
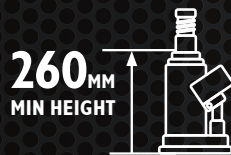

20 TONNE AIR BOTTLE JACK

TQ20007

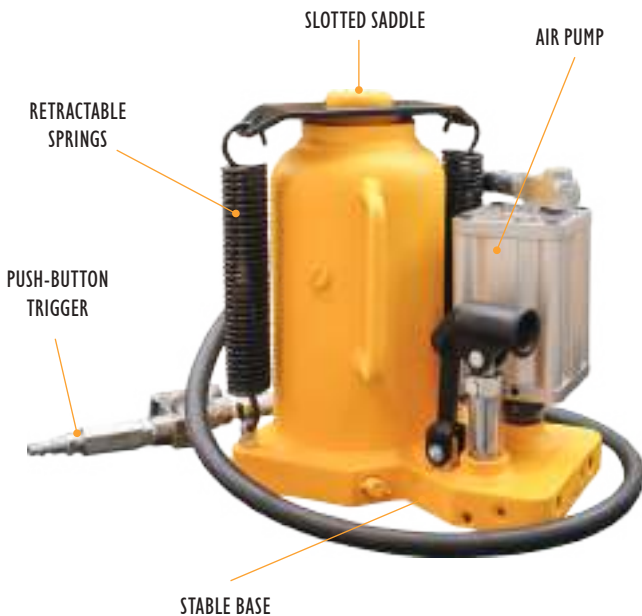

SPECIFICATION

MAX. LOAD	20T
MIN. HEIGHT	255MM
MAX. HEIGHT	500MM
ADJUSTABLE HEIGHT	80MM
NET WEIGHT	17 KG
GROSS WEIGHT	18 KG
PACKAGE SIZE	300X190X285MM
20' CONTAINER	930 PIECE
BARCODE	5056485704976

FEATURES

- Chrome plated cylinder ram.
- High quality aluminium air pump.
- Welded construction.

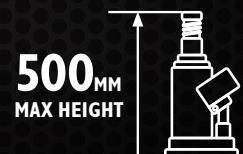
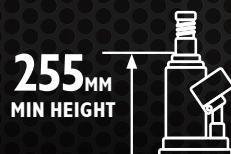

30 TONNE AIR BOTTLE JACK

TQ30007



SPECIFICATION

MAX. LOAD	30T
MIN. HEIGHT	265MM
MAX. HEIGHT	500MM
ADJUSTABLE HEIGHT	100MM
NET WEIGHT	22 KG
GROSS WEIGHT	23.5 KG
PACKAGE SIZE	310X205X295MM
20' CONTAINER	710 PIECE
BARCODE	5056485704983

FEATURES

- Chrome plated cylinder ram.
- High quality aluminium air pump.
- Welded construction.

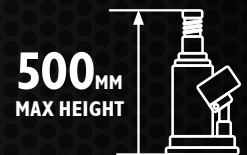
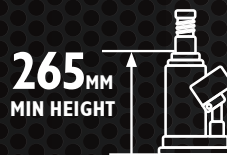

2 TONNE SCISSOR JACK

T10202



SPECIFICATION

MAX. LOAD	2T
MIN HEIGHT	120MM
MAX HEIGHT	395MM
NET WEIGHT	3.5KG
BARCODE	5056485705317

FEATURES

- Made of high-quality steel for strength and durability
- Wide, thickened base
- Solid screw
- Antioxidant spray paint



JACK STANDS

THESE RUGGED, RELIABLE JCB JACK STANDS PROVIDE FIRM, STEADY SUPPORT, ALLOWING YOU TO WORK WITH CONFIDENCE. WITH AN ADJUSTABLE HEIGHT FEATURE, THEY CATER TO A WIDE RANGE OF APPLICATIONS AND VEHICLE SIZES.

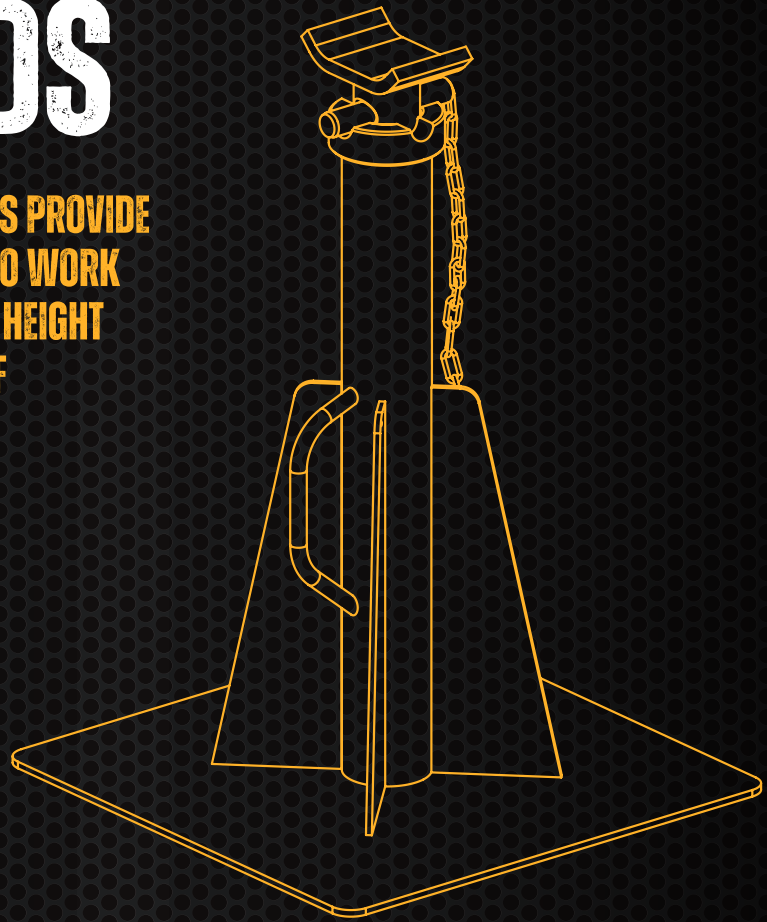

	TH52011	TH53013	TH52002C	TH53003E	TH56002A	T410001	TZ100001
MAX LOAD	2T	3T	2T	3T	6T	10T	10T
MIN HEIGHT	265MM	310MM	278MM	303MM	420MM	303MM	98MM
MAX HEIGHT	365MM	478MM	425MM	438MM	620MM	428MM	508MM
NET WEIGHT	3.6 KG	5.0 KG	5.0 KG	7.0 KG	24.0 KG	27.8 KG	43.1 KG
GROSS WEIGHT	4.3 KG	5.9 KG	5.5 KG	7.5 KG	25.5 KG	29 KG	45.6 KG

	TZ100002	TZ150001	TZ150002	TZ200011	TZ200012	TZ250001	TZ250002
MAX LOAD	10T	15T	15T	20T	20T	25T	25T
MIN HEIGHT	615MM	445MM	645MM	410MM	665MM	415MM	680MM
MAX HEIGHT	1087MM	631MM	1077MM	600MM	1090MM	539MM	968MM
NET WEIGHT	29.9 KG	23.5 KG	29.9 KG	26.1 KG	39.1 KG	24.4 KG	38.5 KG
GROSS WEIGHT	32.5 KG	25.5 KG	38 KG	28.1 KG	41.7 KG	26.4 KG	41.1 KG

2 TONNE JACK STAND SET

TH52011



SPECIFICATION

MAX. LOAD	2T
MIN. HEIGHT	265MM
MAX. HEIGHT	365MM
NET WEIGHT (PAIR)	3.6 KG
GROSS WEIGHT (PAIR)	4.3 KG
PRODUCT SIZE	215X192MM
PACKAGE SIZE	420X295X280MM (2 PAIRS)
20' CONTAINER	1350 PAIRS
BARCODE	5056485704419

FEATURES

- Locking pin is attached to the base with linking chain
- Multiple pin holes to allow adjustment to desired height
- Extra large feet area provide stability and resist sinking into asphalt
- Heavy duty stamped steel design provides stability and rigidity
- Sold and to be used only in pairs

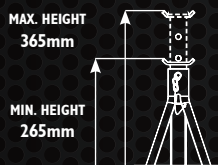

3 TONNE JACK STAND SET

TH53013

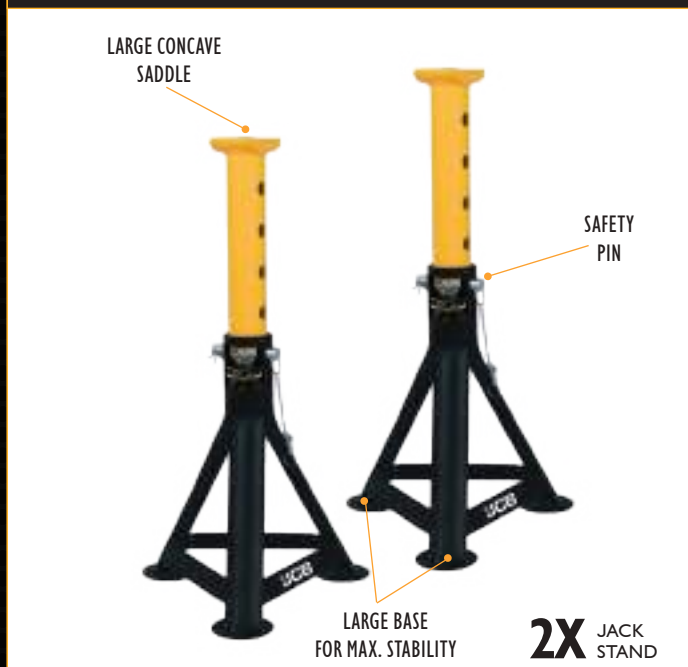

SPECIFICATION

MAX. LOAD	3T
MIN. HEIGHT	310MM
MAX. HEIGHT	478MM
NET WEIGHT (PAIR)	5.0 KG
GROSS WEIGHT (PAIR)	5.9 KG
PRODUCT SIZE	262X225MM
PACKAGE SIZE	675X485X315MM (2 PAIRS)
20' CONTAINER	890 PAIRS
BARCODE	5056485704426

FEATURES

- Locking pin is attached to the base with linking chain
- Multiple pin holes to allow adjustment to desired height
- Extra large feet area provide stability and resist sinking into asphalt
- Heavy duty stamped steel design provides stability and rigidity
- Sold and to be used only in pairs

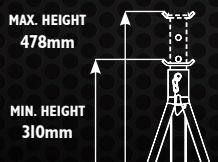

2 TONNE JACK STAND SET

TH52002C



2X JACK STAND

SPECIFICATION

MAX. LOAD	2T
MIN. HEIGHT	278MM
MAX. HEIGHT	425MM
NET WEIGHT (PAIR)	5.0 KG
GROSS WEIGHT (PAIR)	5.5 KG
PRODUCT SIZE	193X175MM
PACKAGE SIZE	210X195X345MM (2 PAIRS)
20' CONTAINER	2000 PAIRS
BARCODE	5056485704433

FEATURES

- Locking pawl with built-in counter weight to secure ratchet bar at designated heights
- Welded design for maximum strength & durability
- Ratchet bar is constructed with ductile iron for increased strength and safety
- Safety pin double locking ratchet action
- Extra large feet area provide stability and resist sinking into asphalt
- Wide base for added stability
- Sold and to be used only in pairs

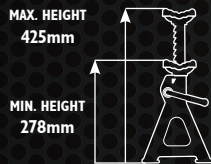

3 TONNE JACK STAND SET

TH53003E



2X JACK STAND

SPECIFICATION

MAX. LOAD	3T
MIN. HEIGHT	303MM
MAX. HEIGHT	438MM
NET WEIGHT (PAIR)	7.0 KG
GROSS WEIGHT (PAIR)	7.5 KG
PRODUCT SIZE	207X188MM
PACKAGE SIZE	220X205X355MM (2 PAIRS)
20' CONTAINER	1700 PAIRS
BARCODE	5056485704440

FEATURES

- Locking pawl with built-in counter weight to secure ratchet bar at designated heights
- Welded design for maximum strength & durability
- Ratchet bar is constructed with ductile iron for increased strength and safety
- Safety pin double locking ratchet action
- Extra large feet area provide stability and resist sinking into asphalt
- Wide base for added stability
- Sold and to be used only in pairs

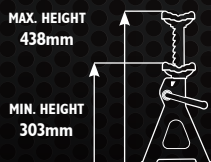

6 TONNE JACK STAND SET

TH56002A



SPECIFICATION

MAX. LOAD	6T
MIN. HEIGHT	420MM
MAX. HEIGHT	620MM
NET WEIGHT (PAIR)	24.0 KG
GROSS WEIGHT (PAIR)	25.5 KG
PRODUCT SIZE	285X250MM
PACKAGE SIZE	315X275X470MM
20' CONTAINER	600 PAIRS
BARCODE	5056485704457

FEATURES

- Locking pawl with built-in counter weight to secure ratchet bar at designated heights
- Welded design for maximum strength & durability
- Ratchet bar is constructed with ductile iron for increased strength and safety
- Safety pin double locking ratchet action
- Extra large feet area provide stability and resist sinking into asphalt
- Wide base for added stability
- Sold and to be used only in pairs

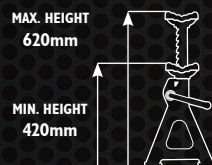

EXTRA SAFETY PIN
DOUBLE LOCKING



RATCHET
ACTION

10 TONNE JACK STAND SET

T410001



SPECIFICATION

MAX. LOAD	10T
MIN. HEIGHT	303MM
MAX. HEIGHT	428MM
NET WEIGHT	27.8 KG
GROSS WEIGHT	29 KG
PACKAGE SIZE	340X310X570MM (2 PAIRS)
20' CONTAINER	448 PAIRS
BARCODE	5056485705133

FEATURES

- Ratchet style allows for fine adjustment and fast removal.
- Solid steel handle, self-locking ratchet.
- Large saddle, unitized frame construction.
- Ductile iron rock.

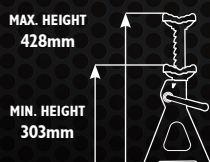

EXTRA SAFETY PIN
DOUBLE LOCKING



RATCHET
ACTION

10 TONNE HEAVY-DUTY JACK STAND

TZ100001

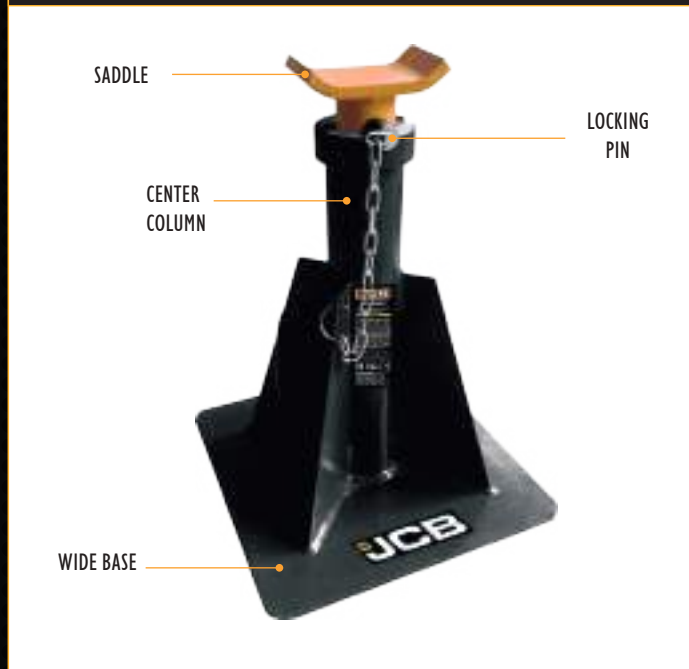

SPECIFICATION

MAX. LOAD	10T
MIN. HEIGHT	98MM
MAX. HEIGHT	508MM
NET WEIGHT	43.1 KG
GROSS WEIGHT	45.6 KG
PRODUCT SIZE	726X342X170MM
PACKAGE SIZE	790X400X200MM
20' CONTAINER	385 PIECE
BARCODE	5056485705171

FEATURES

- Safety pin locking
- Wide base
- Extremely sturdy and solid construction

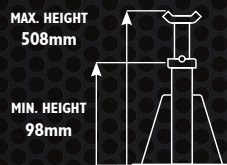

10 TONNE HEAVY-DUTY JACK STAND

TZ100002



SPECIFICATION

MAX. LOAD	10T
MIN. HEIGHT	615MM
MAX. HEIGHT	1087MM
NET WEIGHT	29.9 KG
GROSS WEIGHT	32.5 KG
PRODUCT SIZE	460X460X673MM
PACKAGE SIZE	525X510X680MM
20' CONTAINER	132 PIECE
BARCODE	5056485705188

FEATURES

- Safety pin locking
- Wide base
- Extremely sturdy and solid construction

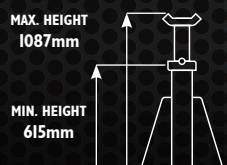

15 TONNE HEAVY-DUTY JACK STAND

TZ150001



SPECIFICATION

MAX. LOAD	15T
MIN. HEIGHT	445MM
MAX. HEIGHT	631MM
NET WEIGHT	23.5 KG
GROSS WEIGHT	25.5 KG
PRODUCT SIZE	330X330X463MM
PACKAGE SIZE	395X390X490MM
20' CONTAINER	280 PIECE
BARCODE	5056485705195

FEATURES

- Safety pin locking
- Wide base
- Extremely sturdy and solid construction

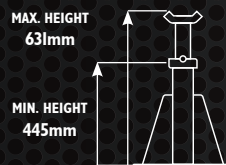

15 TONNE HEAVY-DUTY JACK STAND

TZ150002



SPECIFICATION

MAX. LOAD	15T
MIN. HEIGHT	645MM
MAX. HEIGHT	1077MM
NET WEIGHT	29.9 KG
GROSS WEIGHT	38 KG
PRODUCT SIZE	460X460X663MM
PACKAGE SIZE	525X510X680MM
20' CONTAINER	132 PIECE
BARCODE	5056485705201

FEATURES

- Safety pin locking
- Wide base
- Extremely sturdy and solid construction

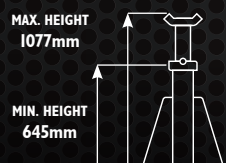

20 TONNE HEAVY-DUTY JACK STAND

TZ200011



SPECIFICATION

MAX. LOAD	20T
MIN. HEIGHT	410MM
MAX. HEIGHT	600MM
NET WEIGHT	26.1 KG
GROSS WEIGHT	28.1 KG
PRODUCT SIZE	330X330X428MM
PACKAGE SIZE	395X390X510MM
20' CONTAINER	280 PIECE
BARCODE	5056485705218

FEATURES

- Wide base
- Extremely sturdy and solid construction

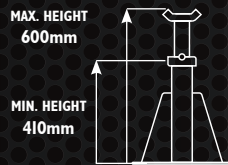

20 TONNE HEAVY-DUTY TALL JACK STAND

TZ200012



SPECIFICATION

MAX. LOAD	20T
MIN. HEIGHT	665MM
MAX. HEIGHT	1090MM
NET WEIGHT	39.1 KG
GROSS WEIGHT	41.7 KG
PRODUCT SIZE	460X460X683MM
PACKAGE SIZE	520X520X720MM
20' CONTAINER	132 PIECE
BARCODE	5056485705225

FEATURES

- Wide base
- Extremely sturdy and solid construction

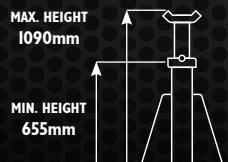

25 TONNE HEAVY-DUTY JACK STAND

TZ250001



SPECIFICATION

MAX. LOAD	25T
MIN. HEIGHT	415MM
MAX. HEIGHT	539MM
NET WEIGHT	24.4 KG
GROSS WEIGHT	26.4 KG
PRODUCT SIZE	330X330X433MM
PACKAGE SIZE	395X390X455MM
20' CONTAINER	350 PIECE
BARCODE	5056485705232

FEATURES

- Safety pin locking
- Wide base
- Extremely sturdy and solid construction

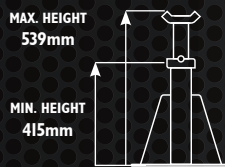

25 TONNE HEAVY-DUTY JACK STAND

TZ250002



SPECIFICATION

MAX. LOAD	25T
MIN. HEIGHT	680MM
MAX. HEIGHT	968MM
NET WEIGHT	38.5 KG
GROSS WEIGHT	41.1 KG
PRODUCT SIZE	460X460X698MM
PACKAGE SIZE	520X510X720MM
20' CONTAINER	132 PIECE
BARCODE	5056485705249

FEATURES

- Safety pin locking
- Wide base
- Extremely sturdy and solid construction

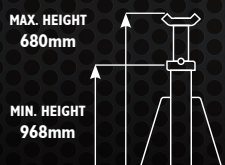

POSITIONING JACKS

MAXIMIZE YOUR PRODUCTIVITY AND EFFICIENCY WITH JCB'S POSITIONING JACKS THAT DELIVER SMOOTH AND PRECISE MOVEMENT FOR PERFECT POSITIONING EVERY TIME.

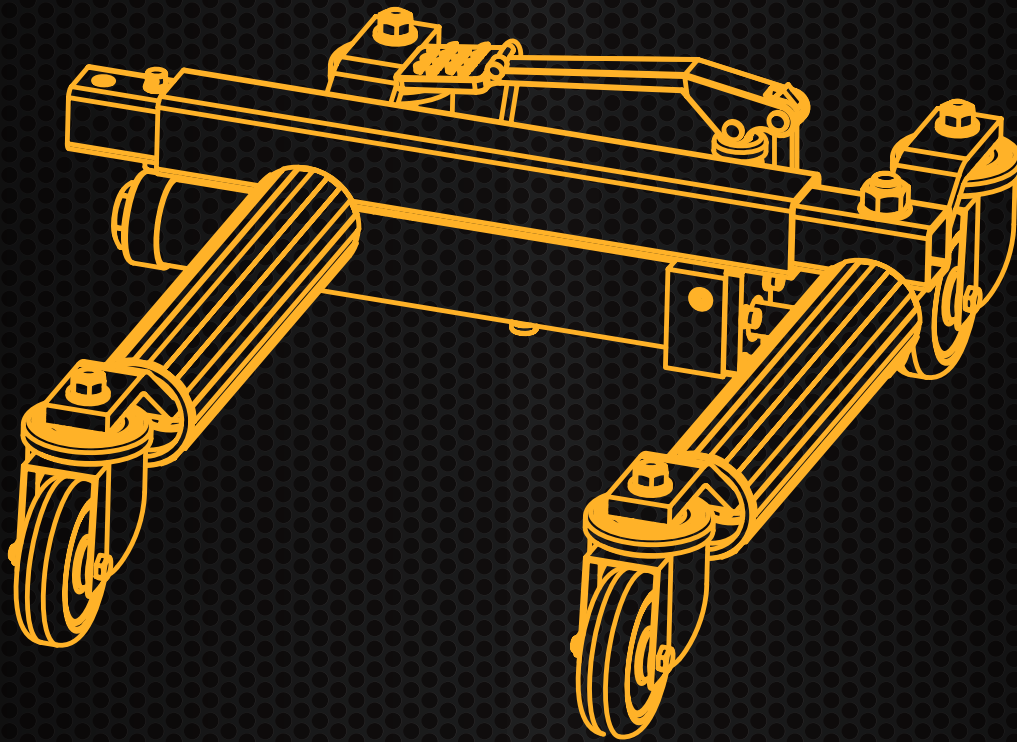

	TX9009	TX9012	TX9012L	TX12002S
				
MAX LOAD	680KG	680KG	680KG	1.5T
NET WEIGHT	17 KG	18 KG	18.5 KG	111 KG
GROSS WEIGHT	18 KG	20 KG	20.5 KG	120 KG
REMARKS	9"	12"	12"	

9" POSITIONING JACK

TX9009



SPECIFICATION

MAX. LOAD	680KG
NET WEIGHT	17 KG
GROSS WEIGHT	18 KG
PACKAGE SIZE	570X570X180MM
20' CONTAINER	480 PIECE
BARCODE	5056485705256

FEATURES

- Easy and compact foot pedal hydraulic lowering pump mechanism
- 4 swivel wheels on the bottom that can rotate in all directions



12" POSITIONING JACK

TX9012



SPECIFICATION

MAX. LOAD	680KG
NET WEIGHT	18 KG
GROSS WEIGHT	20 KG
PACKAGE SIZE	635X570X180MM
20' CONTAINER	430 PIECE
BARCODE	5056485705263

FEATURES

- Easy and compact foot pedal hydraulic lowering pump mechanism
- 4 swivel wheels on the bottom that can rotate in all directions



12" POSITIONING JACK WITH ALUMINIUM ROLLER

TX9012L

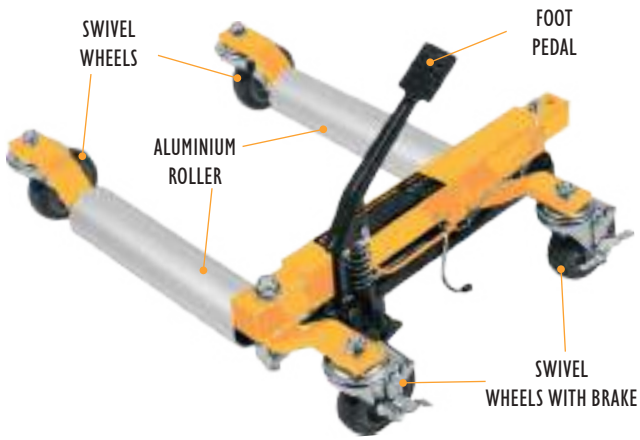

SPECIFICATION

MAX. LOAD	680KG
NET WEIGHT	18.5 KG
GROSS WEIGHT	20.5 KG
PACKAGE SIZE	635X570X180MM
20' CONTAINER	430 PIECE
BARCODE	5056485705256

FEATURES

- Easy and compact foot pedal hydraulic lowering pump mechanism
- 4 swivel wheels on the bottom that can rotate in all directions
- 2 wheels with brake
- Aluminum roller
- High-class design, foldable for storage with specialized hanging brackets



DUAL WHEEL DOLLY

TX12002S



SPECIFICATION

MAX. LOAD	1.5T
MAX HEIGHT	750 MM
MIN/MAX OF THE MOUNTED WHEEL	DIAMETER 1000 – 1800 MM, WIDTH: 160 – 810 MM
NET WEIGHT	111 KG
GROSS WEIGHT	120 KG
PACKAGE SIZE	PACKAGE SIZE:
BARCODE	5056485705287

FEATURES

- 4 swivel wheels provide smooth maneuvering and positioning
- Adjustable support arm
- Pump lever
- Roller table



PORTABLE BODY REPAIR KIT

DESIGNED FOR AUTO REPAIR PROFESSIONALS; COMBINING ROBUST POWER, PRECISION AND DURABILITY TO PERFORM BODY REPAIRS WITH UNPARALLELED EFFICIENCY AND EFFECTIVENESS FOR YEARS.

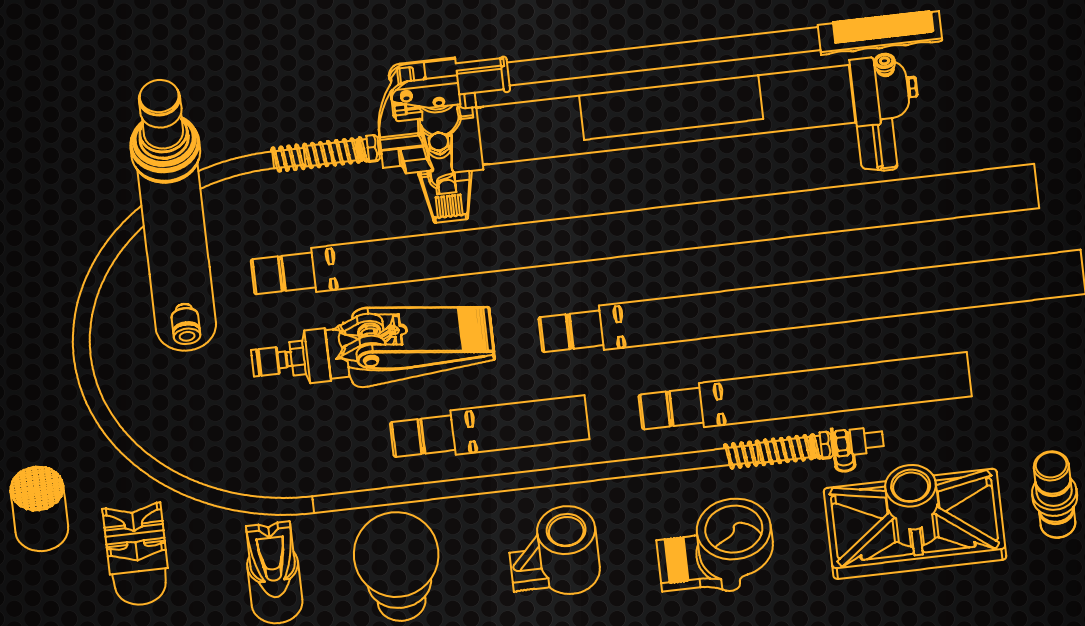

	T70401S	T71002L
MAX LOAD	4 T	10 T
NET WEIGHT	17.2 KG	27.5KG

4 TONNE PORTABLE BODY REPAIR KIT

T70401S



SPECIFICATION

ITEM WEIGHT	17.2 KG
PRODUCT DIMENSIONS	60.96 X 35.56 X 20.32 CM; 17.24 KG
BARCODE	5056485705294

FEATURES

- Complete kit contains a variety of bodywork, frame repair and components for lifting, pushing, pulling, bending, smoothing and spreading
- Ideal for your workshop or garage and has a load Capacity of 4 Tonne; includes 20", 16", 9", 6" and 4" extension tubes with snap lock for quick, easy installation
- Features a serrated saddle, expansion wedge, rubber head, flat base, ram toe, Piston toe, wedge head, V-base, male connector and hydraulic hose
- The pump has an automatic overload system to prevent damage to edges and equipment, the flex head features a permanently moulded rubber pad, interlocking to prevent separation



10 TONNE PORTABLE BODY REPAIR KIT

T71002L



SPECIFICATION

MAX. LOAD	10T
CYLINDER MIN HEIGHT	380MM
CYLINDER LIFTING HEIGHT	150MM
NET WEIGHT	27.5KG
GROSS WEIGHT	35.5KG
PACKAGE SIZE	960X450X210
BARCODE	5056485705300

FEATURES

- Complete kit contains a variety of bodywork, frame repair and components for lifting, pushing, pulling, bending, smoothing and spreading
- Ideal for your workshop or garage and has a 10 ton load capacity; Includes 29-1/4", 20-1/4", 12-1/4", and 7-1/4" extension tubes with a snap-lock design for quick, easy assembly
- Features a serrated saddle, expansion wedge, rubber head, flat base, ram toe, Piston toe, wedge head, V-base, male connector and hydraulic hose
- The pump has an automatic overload system to prevent damage to edges and equipment, the flex head features a permanently moulded rubber pad, interlocking to prevent separation



ENGINE STAND-CRANE

ENGINEERED WITH THE NEEDS OF PROFESSIONAL AUTO MECHANICS IN MIND, JCB'S ENGINE STANDS AND ENGINE CRANES DELIVER SUPERIOR STABILITY, EMBODYING COMMITMENT TO QUALITY, SAFETY AND DURABILITY ENSURING YOUR INVESTMENT STANDS THE TEST OF TIME

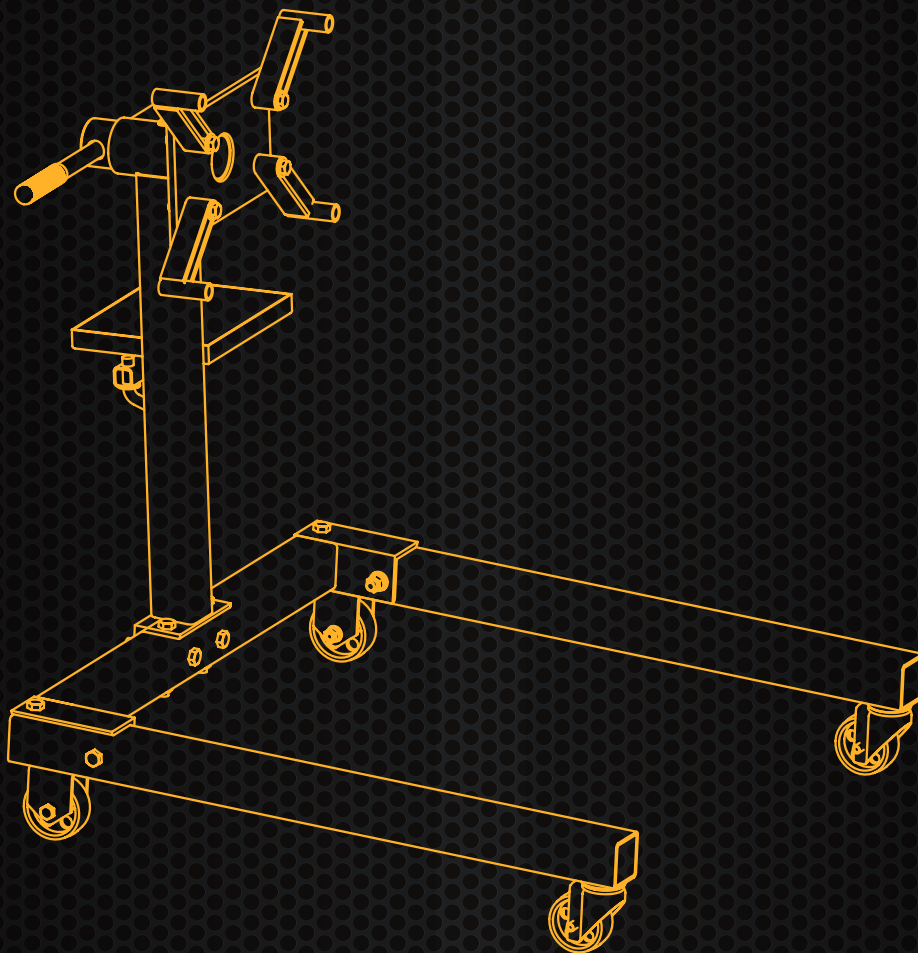

	T2454I	T2567I	T2680I	TH72004
				
MAX LOAD	560 KG	560 KG	680 KG	2 T
NET WEIGHT	21 KG	27.5 KG	33.5 KG	86 KG

450 KG ENGINE STAND

T24541



SPECIFICATION

MAX. LOAD	560 KG
NET WEIGHT	21 KG
GROSS WEIGHT	22.3 KG
PRODUCT SIZE	995X780X850MM
PACKAGE SIZE	870X200X195MM
20' CONTAINER	740 PIECE
BARCODE	5056485705140

FEATURES

- The wheels construction for more stability and easy rolling
- Adjustable mounting arms, accommodate a majority of engine blocks, both foreign and domestic
- Mounting plate rotates 360 degree and can be locked in 8 different positions
- Heavy gauge tubular steel construction
- Roll-around engine stand assembles easily



560 KG ENGINE STAND

T25671



SPECIFICATION

MAX. LOAD	560 KG
NET WEIGHT	27.5 KG
GROSS WEIGHT	29.2 KG
PRODUCT SIZE	995X705X960MM
PACKAGE SIZE	880X215X220MM
20' CONTAINER	640 PIECE
BARCODE	5056485705157

FEATURES

- The wheels construction for more stability and easy rolling
- Adjustable mounting arms, accommodate a majority of engine blocks, both foreign and domestic
- Mounting plate rotates 360 degree and can be locked in 8 different positions
- Heavy gauge tubular steel construction
- Roll-around engine stand assembles easily



680 KG ENGINE STAND

T26801



SPECIFICATION

MAX. LOAD	680 KG
NET WEIGHT	33.5 KG
GROSS WEIGHT	35.3 KG
PRODUCT SIZE	870X820X860MM
PACKAGE SIZE	860X420X165MM
20' CONTAINER	448 PIECE
BARCODE	5056485705164

FEATURES

- The wheels construction for more stability and easy rolling
- Adjustable mounting arms, accommodate a majority of engine blocks, both foreign and domestic
- Mounting plate rotates 360 degree and can be locked in 8 different positions
- Heavy gauge tubular steel construction
- Roll-around engine stand assembles easily



2 TONNE FOLDABLE CRANE

TH72004



SPECIFICATION

NET WEIGHT	86 KG
GROSS WEIGHT	92 KG
20' CONTAINER	175 PIECE
BARCODE	5056485704464

FEATURES

- Hydraulic long ram with built-in by-pass system prevents ram from being over-extended
- Heavy-gauge, welded construction with rugged square tubular steel
- Swivel castors for easy maneuvering and positioning
- Unique folding design for convenient storage

HYDRAULIC PRESSES

JCB'S HYDRAULIC SHOP PRESSES RANGING FROM ROBUST 12 TON PRESSES FOR SMALLER TASKS, TO COLOSSAL 75 TON PRESSES FOR HEAVY-DUTY OPERATIONS, OUR LINE-UP IS DESIGNED TO CATER TO ALL YOUR PRESSING NEEDS. EACH JCB SHOP PRESS COMBINES SOLID CONSTRUCTION, ADVANCED HYDRAULICS, AND USER-FRIENDLY DESIGN, ENSURING YOUR WORK IS NOT ONLY EFFICIENT BUT ALSO SAFE

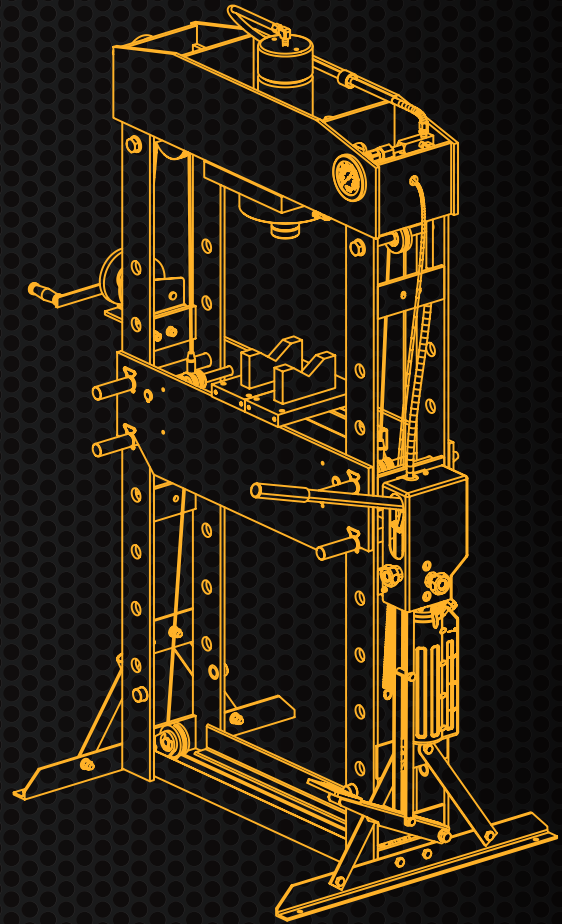

	TY12001	TY12002	TY20001	TY20002	TY20030
					
MAX LOAD	12T	12T	20T	20T	20T
STROKE	165MM	165MM	175MM	175MM	175MM
WORK RANGE	0-340MM	0-920MM	0-910MM	0-910MM	0-900MM

	TY30030	TY50030	TY30002	TY40001	TY50001	TY75021
						
MAX LOAD	30T	50T	30T	40T	50T	75T
STROKE	150MM	200MM	150MM	175MM	175MM	240MM
WORK RANGE	0-940MM	0-920MM	0-970MM	0-1080MM	0-890MM	0-900MM

12 TONNE HYDRAULIC PRESS

TY12001

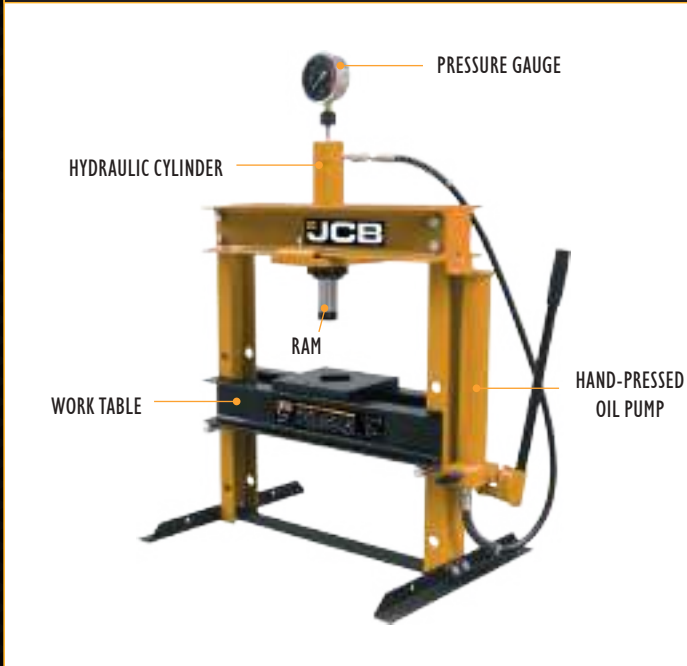

SPECIFICATION

MAX. LOAD	12T
STROKE	165MM
WORK RANGE	0-340MM
NET WEIGHT	56.5 KG
GROSS WEIGHT	58.5 KG
PACKAGE SIZE	795X420X180MM
20' CONTAINER	287 PIECE
BARCODE	5056485705331

FEATURES

- Heavy-duty H-frame constructed of high-grade steel and built to exacting standards for quality and durability
- High quality large diameter hydraulic steel cylinder unit results in lower oil pressure needed to raise the load, helping to reduce wear and extend service life
- Hydraulics are powered with a high quality oil, which offers better corrosion resistance and high/low temperature flexibility



WORKING RANGE
0-340mm

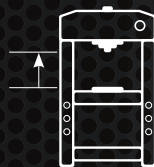

12 TONNE HYDRAULIC PRESS

TY12002



SPECIFICATION

MAX. LOAD	12T
STROKE	165MM
WORK RANGE	0-920MM
NET WEIGHT	1- 54.5 KG / 2- 14 KG
GROSS WEIGHT	1- 56.5 KG / 2- 15 KG
PACKAGE SIZE	1- 1390X175X215MM / 2- 675X230X170MM
20' CONTAINER	234 PIECE
BARCODE	5056485705340

FEATURES

- Heavy-duty H-frame constructed of high-grade steel and built to exacting standards for quality and durability
- High quality large diameter hydraulic steel cylinder unit results in lower oil pressure needed to raise the load, helping to reduce wear and extend service life
- Hydraulics are powered with a high quality oil, which offers better corrosion resistance and high/low temperature flexibility



WORKING RANGE
0-920mm

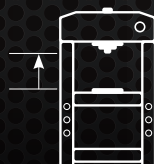

20 TONNE HYDRAULIC PRESS

TY20001

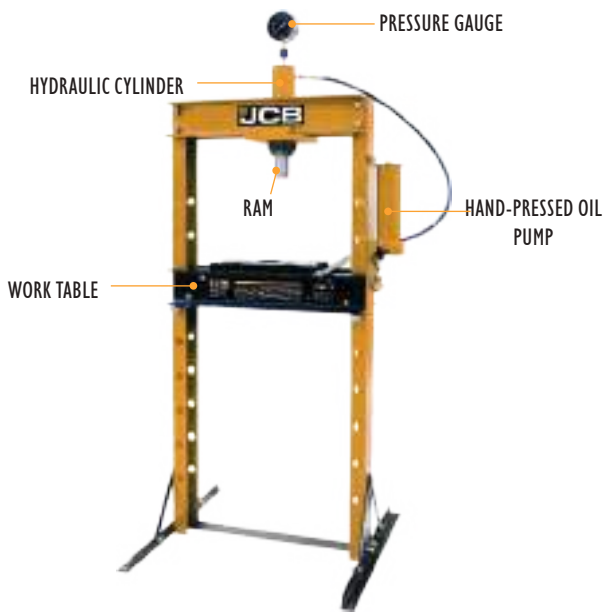

SPECIFICATION

MAX. LOAD	20T
STROKE	175MM
WORK RANGE	0-910MM
NET WEIGHT	1- 60.8 KG / 2- 36 KG
GROSS WEIGHT	1- 61.8 KG / 2- 37 KG
PACKAGE SIZE	1- 1565X185X145MM / 2- 795X330X150MM
20' CONTAINER	170 PIEC
BARCODE	5056485705355

FEATURES

- Heavy-duty H-frame constructed of high-grade steel and built to exacting standards for quality and durability
- High quality large diameter hydraulic steel cylinder unit results in lower oil pressure needed to raise the load, helping to reduce wear and extend service life
- Hydraulics are powered with a high quality oil, which offers better corrosion resistance and high/low temperature flexibility

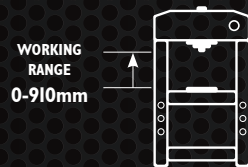

20 TONNE HYDRAULIC PRESS

TY20002

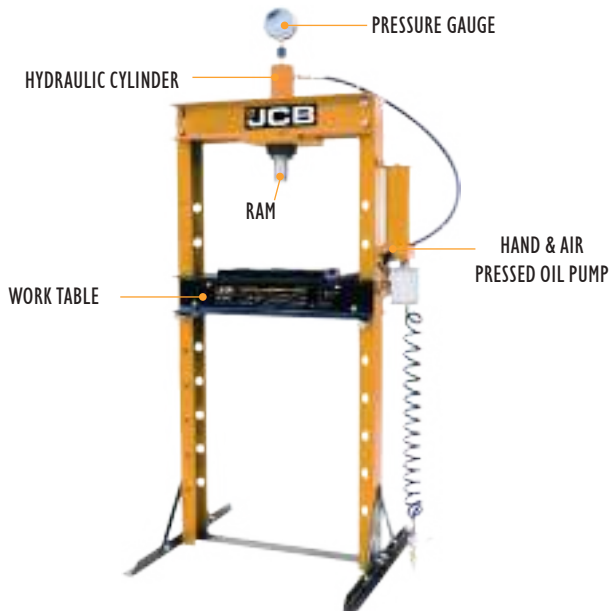

SPECIFICATION

MAX. LOAD	20T
STROKE	175MM
WORK RANGE	0-910MM
NET WEIGHT	1- 60.8 KG / 2- 37.5 KG
GROSS WEIGHT	1- 61.8 KG / 2- 38.5 KG
PACKAGE SIZE	1- 1565X185X145MM / 2- 795X330X150MM
20' CONTAINER	170 PIECE
BARCODE	5056485705362

FEATURES

- Heavy-duty H-frame constructed of high-grade steel and built to exacting standards for quality and durability
- High quality large diameter hydraulic steel cylinder unit results in lower oil pressure needed to raise the load, helping to reduce wear and extend service life
- Hydraulics are powered with a high quality oil, which offers better corrosion resistance and high/low temperature flexibility

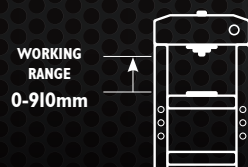

20 TONNE HYDRAULIC PRESS

TY20030



SPECIFICATION

MAX. LOAD	20T
STROKE	175MM
WORK RANGE	0-900MM
NET WEIGHT	106KG
GROSS WEIGHT	133KG
PACKAGE SIZE	1700X835X300MM
20' CONTAINER	42 PIECE
BARCODE	5056485705379

FEATURES

- Heavy-duty H-frame constructed of high-grade steel and built to exacting standards for quality and durability
- High quality large diameter hydraulic steel cylinder unit results in lower oil pressure needed to raise the load, helping to reduce wear and extend service life
- Hydraulics are powered with a high quality oil, which offers better corrosion resistance and high/low temperature flexibility



WORKING RANGE
0-900mm

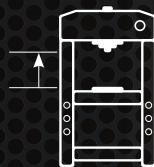

30 TONNE HYDRAULIC PRESS

TY30030



SPECIFICATION

MAX. LOAD	30T
STROKE	150MM
WORK RANGE	0-940MM
NET WEIGHT	135KG
GROSS WEIGHT	159KG
PACKAGE SIZE	1700X835X300MM
20' CONTAINER	42 PIECE
BARCODE	5056485705386

FEATURES

- Heavy-duty H-frame constructed of high-grade steel and built to exacting standards for quality and durability
- High quality large diameter hydraulic steel cylinder unit results in lower oil pressure needed to raise the load, helping to reduce wear and extend service life
- Hydraulics are powered with a high quality oil, which offers better corrosion resistance and high/low temperature flexibility



WORKING RANGE
0-940mm

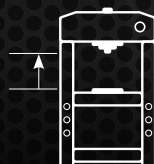

50 TONNE HYDRAULIC PRESS

TY50030



SPECIFICATION

MAX. LOAD	50T
STROKE	200MM
WORK RANGE	0-920MM
NET WEIGHT	297KG
GROSS WEIGHT	345KG
PACKAGE SIZE	2008X1168X428MM
20' CONTAINER	20 PIECE
BARCODE	5056485705393

FEATURES

- Heavy-duty H-frame constructed of high-grade steel and built to exacting standards for quality and durability
- High quality large diameter hydraulic steel cylinder unit results in lower oil pressure needed to raise the load, helping to reduce wear and extend service life
- Hydraulics are powered with a high quality oil, which offers better corrosion resistance and high/low temperature flexibility

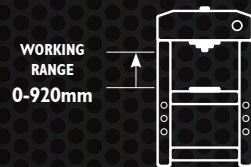

30 TONNE HYDRAULIC PRESS

TY30002

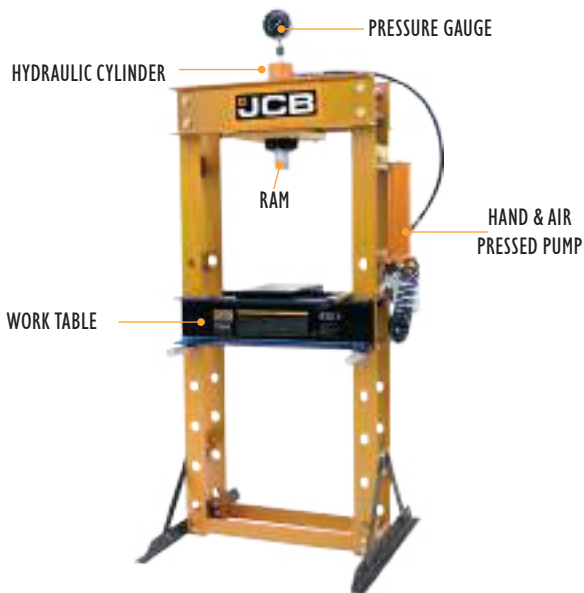

SPECIFICATION

MAX. LOAD	30T
STROKE	150MM
WORK RANGE	0-970MM
NET WEIGHT	152 KG
GROSS WEIGHT	165 KG
PACKAGE SIZE	1640X380X310MM
20' CONTAINER	100 PIECE
BARCODE	5056485705409

FEATURES

- Heavy-duty H-frame constructed of high-grade steel and built to exacting standards for quality and durability
- High quality large diameter hydraulic steel cylinder unit results in lower oil pressure needed to raise the load, helping to reduce wear and extend service life
- Hydraulics are powered with a high quality oil, which offers better corrosion resistance and high/low temperature flexibility

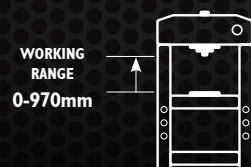

40 TONNE HYDRAULIC PRESS

TY40001

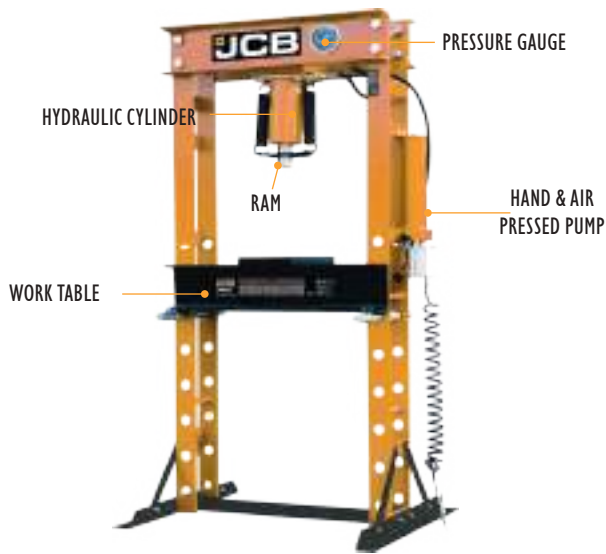

SPECIFICATION

MAX. LOAD	40T
STROKE	175MM
WORK RANGE	0-1080MM
NET WEIGHT	225KG
GROSS WEIGHT	247KG
PACKAGE SIZE	2010X550X330MM
20' CONTAINER	60 PIECE
BARCODE	5056485705416

FEATURES

- Heavy-duty H-frame constructed of high-grade steel and built to exacting standards for quality and durability
- High quality large diameter hydraulic steel cylinder unit results in lower oil pressure needed to raise the load, helping to reduce wear and extend service life
- Hydraulics are powered with a high quality oil, which offers better corrosion resistance and high/low temperature flexibility



WORKING RANGE
0-1080mm

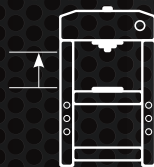

50 TONNE HYDRAULIC PRESS

TY50001



SPECIFICATION

MAX. LOAD	50T
STROKE	175MM
WORK RANGE	0-890MM
NET WEIGHT	256KG
GROSS WEIGHT	286KG
PACKAGE SIZE	920X380X1792MM
20' CONTAINER	36 PIECE
BARCODE	5056485705423

FEATURES

- Heavy-duty H-frame constructed of high-grade steel and built to exacting standards for quality and durability
- High quality large diameter hydraulic steel cylinder unit results in lower oil pressure needed to raise the load, helping to reduce wear and extend service life
- Hydraulics are powered with a high quality oil, which offers better corrosion resistance and high/low temperature flexibility



WORKING RANGE
0-890mm

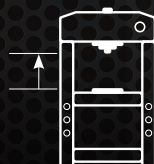

75 TONNE HYDRAULIC PRESS

TY75021

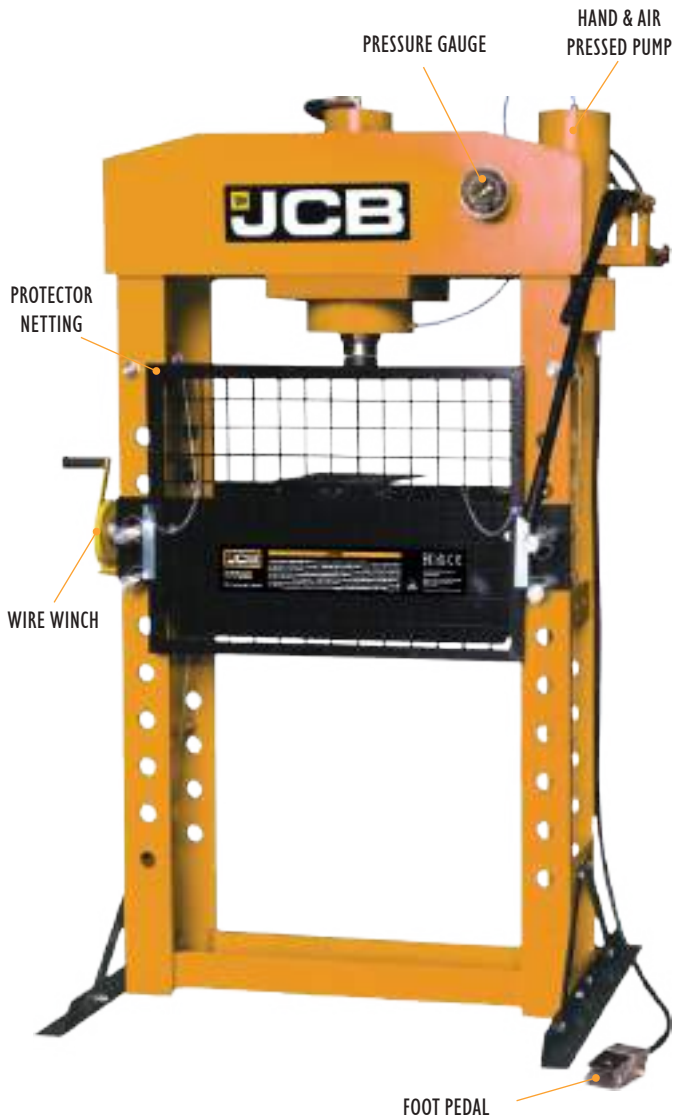

SPECIFICATION

MAX. LOAD	75T
STROKE	240MM
WORK RANGE	0-900MM
NET WEIGHT	457KG
GROSS WEIGHT	530KG
PACKAGE SIZE	1370X840X2124MM
20' CONTAINER	10 PIECE
BARCODE	5056485705430

FEATURES

- Heavy-duty H-frame constructed of high-grade steel and built to exacting standards for quality and durability
- High quality large diameter hydraulic steel cylinder unit results in lower oil pressure needed to raise the load, helping to reduce wear and extend service life
- Hydraulics are powered with a high quality oil, which offers better corrosion resistance and high/low temperature flexibility

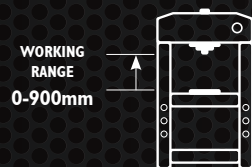

AIR TOOLS

UNLEASH THE POWER OF AIR WITH JCB'S PNEUMATIC AIR TOOLS. EACH TOOL IN OUR PNEUMATIC RANGE IS DESIGNED FOR OPTIMAL PERFORMANCE, DURABILITY, AND USER COMFORT. WITH JCB PNEUMATIC AIR TOOLS, YOU'RE NOT JUST WORKING WITH AIR, YOU'RE HARNESSING ITS POWER TO DRIVE PRODUCTIVITY TO NEW HEIGHTS.

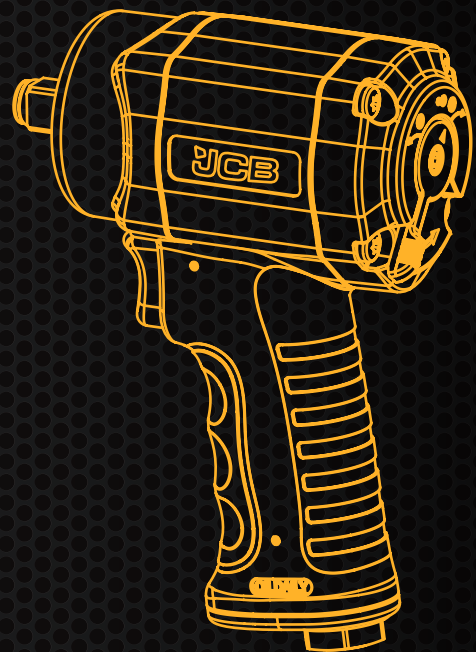
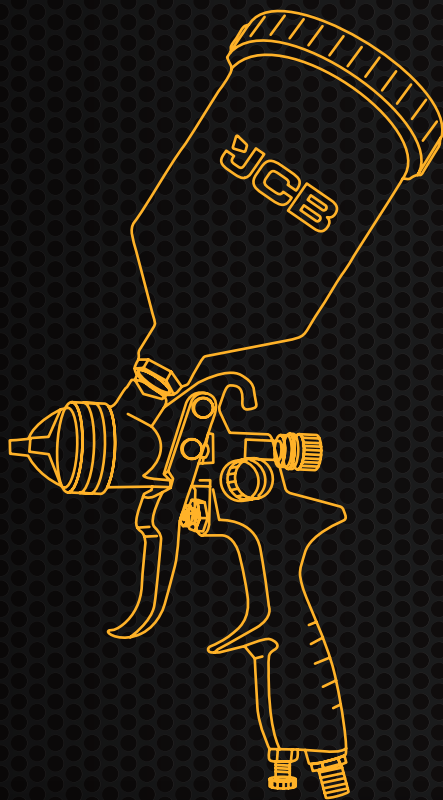

	RP9515 / RP9515KIT	RP9510 / RP9510 KIT	RP7460	RP7463	RP7495	BL-1050
						
SQUARE DRIVE	1/2"	1/2"	3/4"	1"	1"	1"
NO LOAD SPEED	8500 RPM	7000 RPM	7000 RPM	6000 RPM	2800RPM	2600RPM
MAX. FORWARD TORQUE	610 NM	1450 NM	1800 NM	2000 NM		4000 NM
MAX LOOSENING TORQUE:	1200 NM	1600 NM	2000 NM			
AIR INLET SIZE	1/4"	1/4"	3/8"	1/2"	1/2"	1/2"
NET WEIGHT	1.2 KG	2 KG	3 KG	7.8 KG	18.9 KG	21 KG

	RP7408	RP7412	RP7414	RP7810 (RP7102)	RP7314
					
SQUARE DRIVE	1/2"	3/8"	1/4"	10 MM CHUCK	1/4"
NO LOAD SPEED	160 RPM	160 RPM	240 RPM	1800 RPM	25000 RPM
MAX. FORWARD TORQUE	68 NM	68 NM	36 NM		
AIR INLET SIZE	1/4"	1/4"	1/4"	1/4"	1/4"
NET WEIGHT	1.2 KG	1.1 KG	1.1 KG	1.1 KG	1.2 KG

	RP8037-2	"R8761 (RP8033-1)	RP8033-1	RP8037-2
				
MAX. OPERATING PRESSURE	0-8.8 BAR	6.2 BAR (90 PSI)	6.2 BAR (90 PSI)	0-8.8 BAR
LENGHT OF AIR HOSE (OR NOZZLE)	350 MM	150 MM	150 MM	350 MM
AIR INLET SIZE	1/4"	1/4"	1/4"	1/4"
NET WEIGHT	0.40 KG			

	A612	H827	I020	R8826	RP8048
					
PRODUCT NAME	AIR TYRE INFLATOR GUN	AIR SPRAY GUN	AIR SPRAY GUN	AIR SPRAY GUN KIT	AIR SAND BLASTER GUN KIT

1/2" AIR IMPACT WRENCH

RP9515

SQUARE DRIVE
HEAD 1/2"



SPECIFICATION

SQUARE DRIVE	1/2"
NO LOAD SPEED	8500 RPM
MAX. FORWARD TORQUE	610 NM
MAX LOOSENING TORQUE:	1200 NM
AIR INLET SIZE	1/4"
AIR HOSE (ID)	8MM (3/8")
AVG AIR CONSUMPTION:	170 L/MIN
NET WEIGHT	1.2 KG
BARCODE	5056485704327

FEATURES

- 1/2" Square ultrahigh alloy steel, provide superior resistance to impact and abrasion
- Orbital trigger design easier to use
- Direction Switch
- Improved air inlet effectively to reduce the tapped damage when maintenance

1/2"

SQUARE DRIVE



1/4"
AIR INLET SIZE



6.3 Bar
(90Psi)
MAX. WORKING PRESSURE

610Nm

MAX. TORQUE

ACCESSORIES
INCLUDED

1/2" AIR IMPACT WRENCH WITH SOCKET SET

RP9515KIT

SQUARE DRIVE
HEAD 1/2"



SPECIFICATION

SQUARE DRIVE	1/2"
NO LOAD SPEED	8500 RPM
MAX. FORWARD TORQUE	610 NM
MAX LOOSENING TORQUE:	1200 NM
AIR INLET SIZE	1/4"
AIR HOSE (ID)	8MM (3/8")
AVG AIR CONSUMPTION:	170 L/MIN
NET WEIGHT	1.2 KG
BARCODE	5056485704334

Hard Case, 10x Impact Sockets (9,10,11,13,14,17,19,22,24,27mm), 5" Extension Bar, Oil Pot, Hex Wrench, Mini Oiler

FEATURES

- 1/2" Square ultrahigh alloy steel, provide superior resistance to impact and abrasion
- Orbital trigger design easier to use
- Direction Switch
- Improved air inlet effectively to reduce the tapped damage when maintenance

1/2"

SQUARE DRIVE



1/4"
AIR INLET SIZE



6.3 Bar
(90Psi)
MAX. WORKING PRESSURE

610Nm

MAX. TORQUE

ACCESSORIES
INCLUDED

1/2" AIR IMPACT WRENCH

RP9510



SPECIFICATION

SQUARE DRIVE	1/2"
NO LOAD SPEED	7000 RPM
MAX. FORWARD TORQUE	1450 NM
MAX LOOSENING TORQUE:	1600 NM
AIR INLET SIZE	1/4"
AIR HOSE (ID)	8MM (3/8")
AVG AIR CONSUMPTION:	198 L/MIN
NET WEIGHT	2 KG
BARCODE	5056485704143

FEATURES

- 1/2" Square ultrahigh alloy steel, provide superior resistance to impact and abrasion
- Orbital trigger design easier to use
- Direction Switch
- Improved air inlet effectively to reduce the tapped damage when maintenance
- Twin hammer mechanism

1/2"
SQUARE DRIVE

1/4"
AIR INLET SIZE

6.3 Bar
(90Psi)
MAX. WORKING PRESSURE

1450Nm
MAX. TORQUE

TWIN HAMMER
MECHANISM

ACCESSORIES
INCLUDED

1/2" AIR IMPACT WRENCH KIT

RP9510 KIT



SPECIFICATION

SQUARE DRIVE	1/2"
NO LOAD SPEED	7000 RPM
MAX. FORWARD TORQUE	1450 NM
MAX LOOSENING TORQUE:	1600 NM
AIR INLET SIZE	1/4"
AIR HOSE (ID)	10MM (3/8")
AVG AIR CONSUMPTION:	198 L/MIN
NET WEIGHT	2 KG
BARCODE	5056485704167

Hard Case, 3x 1/2" Impact Sockets (17mm, 19mm, 21mm), Oil Bottle

FEATURES

- 1/2" Square ultrahigh alloy steel, provide superior resistance to impact and abrasion
- Orbital trigger design easier to use
- Direction Switch
- Improved air inlet effectively to reduce the tapped damage when maintenance
- Twin hammer mechanism

1/2"
SQUARE DRIVE

1/4"
AIR INLET SIZE

6.3 Bar
(90Psi)
MAX. WORKING PRESSURE

1450Nm
MAX. TORQUE

TWIN HAMMER
MECHANISM

ACCESSORIES
INCLUDED

3/4" AIR IMPACT WRENCH

RP7460



SPECIFICATION

SQUARE DRIVE	3/4"
NO LOAD SPEED	7000 RPM
MAX. FORWARD TORQUE	1800 NM
MAX LOOSENING TORQUE:	2000 NM
AIR INLET SIZE	3/8"
AIR HOSE (ID)	8MM (3/8")
AVG AIR CONSUMPTION:	230 L/MIN
NET WEIGHT	3 KG
BARCODE	5056485704150

FEATURES

- 3/4" Square ultrahigh alloy steel, provide superior resistance to impact and abrasion
- Orbital trigger design easier to use
- Direction Switch
- Improved air inlet effectively to reduce the tapped damage when maintenance
- Twin hammer mechanism

3/4"

SQUARE DRIVE



3/8"

AIR INLET SIZE



6.3 Bar
(90Psi)

MAX. WORKING PRESSURE

1800Nm

MAX. TORQUE

TWIN HAMMER
MECHANISM

ACCESSORIES
INCLUDED

1" AIR IMPACT WRENCH

RP7463



SPECIFICATION

SQUARE DRIVE	1"
AIR CONSUMPTION	320 L/MIN
NO LOAD SPEED	6000 RPM
MAX. TORQUE	2000 NM
AIR INLET SIZE	1/2"
AIR HOSE (ID)	16MM (5/8")
LENGHT	340 MM
OPERATING PRESSURE	90 PSI (6.3 BAR)
NET WEIGHT	7.8 KG
BARCODE	5056485704266

FEATURES

- 1" Square ultrahigh alloy steel, provide superior resistance to impact and abrasion
- Provide 4 kinds of speed with forward and reverse
- Ergonomic handle to comfort and control
- Improved air inlet effectively to reduce the tapped damage when maintenance
- Trigger design easier to use

1"

SQUARE DRIVE



1/2"

AIR INLET SIZE



6.3 Bar
(90Psi)

MAX. WORKING PRESSURE

2000Nm

MAX. TORQUE

ACCESSORIES
INCLUDED

1" AIR IMPACT WRENCH

RP7495



SPECIFICATION

SQUARE DRIVE	1"
CAPACITY BOLD SIZE	2" (50MM)
NO LOAD SPEED	2800RPM
WORKING TORQUE	3480 NM
OVERALL LENGHT	644 MM
AIR INLET SIZE	1/2"
AIR HOSE (ID)	16MM (5/8")
AVG AIR CONSUMPTION:	340 L/MIN
SUG. AIR COMP	5 HP
NET WEIGHT	18.9 KG
BARCODE	5056485704174

1"

SQUARE DRIVE



AIR INLET SIZE

5/8"

AIR HOSE (ID)

3480Nm

WORKING TORQUE

ACCESSORIES INCLUDED

1" AIR IMPACT WRENCH

BL-1050



SPECIFICATION

SQUARE DRIVE	1"
CAPACITY BOLD SIZE	2" (50MM)
NO LOAD SPEED	2600RPM
WORKING TORQUE	4000 NM
OVERALL LENGHT	644 MM
AIR INLET SIZE	1/2"
AIR HOSE (ID)	16MM (5/8")
AVG AIR CONSUMPTION:	480 L/MIN
SUG. AIR COMP	5 HP
NET WEIGHT	21 KG
BARCODE	5056485705454

1"

SQUARE DRIVE



AIR INLET SIZE

5/8"

AIR HOSE (ID)

4000Nm

WORKING TORQUE

ACCESSORIES INCLUDED

1/2" AIR RATCHET WRENCH

RP7408

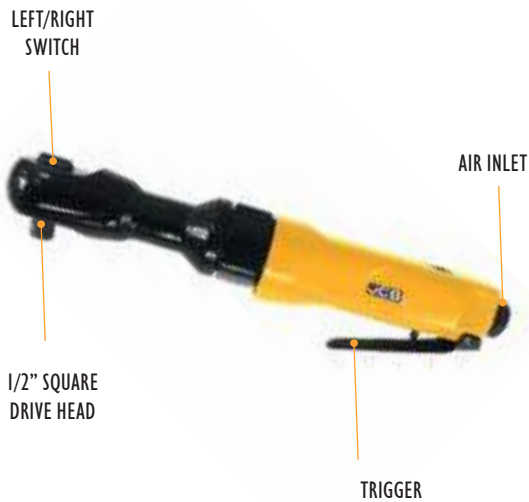

SPECIFICATION

SQUARE DRIVE	1/2"
CAPACITY BOLD SIZE	13 MM
NO LOAD SPEED	160 RPM
WORKING TORQUE	68 NM
OVERALL LENGHT	254 MM
AIR INLET SIZE	1/4"
AIR HOSE (ID)	10MM (3/8")
AVG AIR CONSUMPTION:	85 L/MIN (3 CFM)
SUG. AIR COMP	1 HP
NET WEIGHT	1.2 KG
BARCODE	5056485704235

1/2"
SQUARE DRIVE

 **1/4"**
AIR INLET SIZE

 **6.3 Bar**
(90Psi)
MAX. WORKING PRESSURE

68Nm
WORKING TORQUE

ACCESSORIES INCLUDED

3/8" AIR RATCHET WRENCH

RP7412



SPECIFICATION

SQUARE DRIVE	3/8"
CAPACITY BOLD SIZE	-
NO LOAD SPEED	160 RPM
WORKING TORQUE	68 NM
OVERALL LENGHT	254 MM
AIR INLET SIZE	1/4"
AIR HOSE (ID)	10MM (3/8")
AVG AIR CONSUMPTION:	77 L/MIN (2.7 CFM)
SUG. AIR COMP	1 HP
NET WEIGHT	1.1 KG
BARCODE	5056485704242

3/8"
SQUARE DRIVE

 **1/4"**
AIR INLET SIZE

 **6.3 Bar**
(90Psi)
MAX. WORKING PRESSURE

68Nm
WORKING TORQUE

ACCESSORIES INCLUDED

1/4" AIR RATCHET WRENCH

RP7414

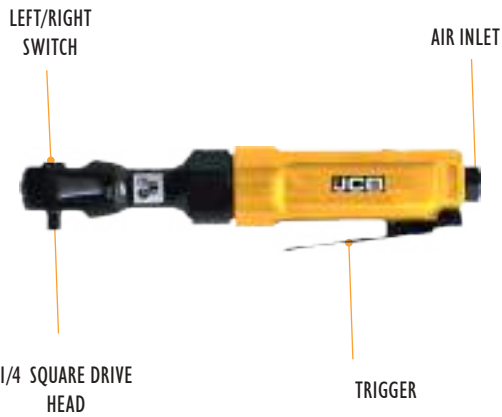

SPECIFICATION

SQUARE DRIVE	1/4"
CAPACITY BOLD SIZE	8 MM (5/16")
NO LOAD SPEED	240 RPM
WORKING TORQUE	36 NM
OVERALL LENGHT	200 MM
AIR INLET SIZE	1/4"
AIR HOSE (ID)	10MM (3/8")
AVG AIR CONSUMPTION:	77 L/MIN (2.7 CFM)
SUG. AIR COMP	1 HP
NET WEIGHT	1.1 KG
BARCODE	5056485704259

1/4"
SQUARE DRIVE



36Nm
WORKING TORQUE

ACCESSORIES INCLUDED

AIR DRILL KIT

RP7810
(RP7102)



SPECIFICATION

NO LOAD SPEED	1800 RPM
CHUCK	10 MM KEYLESS
AIR INLET SIZE	1/4"
AIR HOSE (ID)	10MM (3/8")
AVG AIR CONSUMPTION:	105 L/MIN (3.7 CFM)
NET WEIGHT	1.1 KG
BARCODE	5056485704273

7x Screwdriver Bit Set, 3/8" (8mm) Air Hose Connector, Oil Bottle

KEYLESS CHUCK



ACCESSORIES INCLUDED

1/4" AIR DIE GRINDER

RP7314

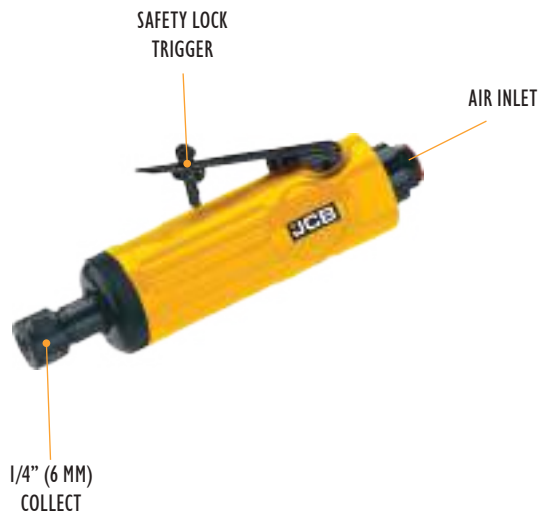

SPECIFICATION

COLLECT CONNECTOR	1/4" (6 MM)
NO LOAD SPEED	25000 RPM
AIR INLET SIZE	1/4"
AIR HOSE (ID)	10MM (3/8")
AVG AIR CONSUMPTION:	128.3 L/MIN (4.5 CFM)
NET WEIGHT	1.2 KG
BARCODE	5056485704259

2x Wrenches (14mm and 19mm), 1/8" (3mm) Collet, 1/4" (6.3mm) Air Hose Connector

1/4"
COLLECT



ACCESSORIES
INCLUDED

AIR TIRE INFLATOR GUN

A612



SPECIFICATION

GAUGE CALIBRATED	0-203 PSI (0 TO 14 BAR)
READOUT RESOLUTION	0.1 PSI
TEMPERATURE RANGE	-18°C TO 40°C
AIR INLET	1/4"
UNUT OF MEASURE	PSI, BAR, KPA, KG/CM ²
ACCURACY	±1%
BATTERY REQUIREMENTS	2X AAA INCLUDED
EASY TO READ GAUGE	2.5"
BARCODE	5056485704181

2x AAA Battery, Dual Head Nozzle Adapter

2.5" LCD
DISPLAY



3 FUNCTIONS
INFLATION | DEFLATION | MEASUREMENT

ACCESSORIES
INCLUDED

AIR INFLATOR TYRE PRESSURE GUN

RP8037-2



SPECIFICATION

MAX. OPERATING PRESSURE	0-8.8 BAR
LENGHT OF AIR HOSE	350 MM
AIR INLET SIZE	1/4"
NET WEIGHT	0.40 KG
BARCODE	50564857044358

FEATURES

- Extended rubber hose
- Analog Tire Pressure Gauge
- 1/4" Air inlet
- Regular nozzle



AIR BLOW GUN KIT

R8761
(RP8033-1)



SPECIFICATION

MAX. WORKING PRESSURE	6,2 BAR (90 PSI)
LENGHT	150 MM
AIR INLET SIZE	1/4"
NOZZLE	2,5 MM
BARCODE	50564857044129

1 x 1/4" Female Connector, 1x2.5 cm Short Nozzle, 1x15 cm Long Nozzle



ACCESSORIES
INCLUDED

6 PIECE AIR TOOL KIT

R8031K6
(RP8037-2, RP8033-1)



SPECIFICATION for RP8033-1

MAX. WORKING PRESSURE	6.2 BAR (90 PSI)
LENGHT	150 MM
AIR INLET SIZE	1/4"
NOZZLE	2,5 MM

SPECIFICATION for RP8037-2

MAX. OPERATING PRESSURE	0-8.8 BAR
LENGHT OF AIR HOSE	350 MM
AIR INLET SIZE	1/4"
BARCODE	5056485704341

5m Air Hose with quick connection, 3x air Needles



ACCESSORIES
INCLUDED

AIR SPRAY GUN

H827



SPECIFICATION

NOZZLE	Ø1.4 MM
RECOMMENDED AIR PRESSURE	2.0-3.5 BAR
SPRAYING WIDTH	180-250 MM
PAINT CONTAINER	600 ML
AIR CONSUMPTION	240-300 L/MIN
AIR INLET	1/4"
BARCODE	5056485704198

FEATURES

- Stainless nozzle and needle
- Suitable for water based paint
- 600ml paint container
- Control knobs for fluid, pattern and air volume



AIR SPRAY GUN

1020

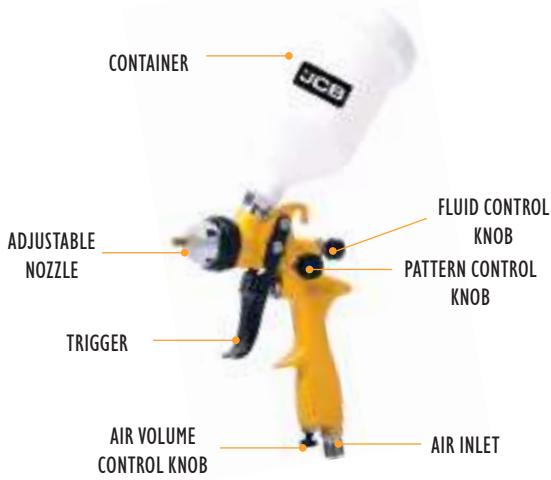

SPECIFICATION

NOZZLE	Ø1.4 MM
RECOMMENDED AIR PRESSURE	2.0-3.5 BAR
SPRAYING WIDTH	180-250 MM
PAINT CONTAINER	600 ML
AIR CONSUMPTION	120-200 L/MIN
AIR INLET	1/4"
BARCODE	5056485704204

FEATURES

- Stainless nozzle and needle
- Suitable for water based paint
- 600ml paint container
- Control knobs for fluid, pattern and air volume



AIR INLET SIZE



HOPPER CAPACITY

3 PIECE AIR SPRAY GUN KIT

**R8826
(H827, H2000)**



SPECIFICATION for H827

NOZZLE	Ø1.4 MM
RECOMMENDED AIR PRESSURE	2.0-3.5 BAR
SPRAYING WIDTH	180-250 MM
PAINT CONTAINER	600 ML
AIR CONSUMPTION	240-300 L/MIN

SPECIFICATION for H2000

NOZZLE	Ø1.0 MM
RECOMMENDED AIR PRESSURE	3.0-4.0 BAR
SPRAYING WIDTH	110-160 MM
PAINT CONTAINER	110-160 L/MIN
AIR CONSUMPTION	125 ML
BARCODE	5056485704211



AIR INLET SIZE



HOPPER CAPACITY

AIR SAND BLASTER GUN KIT

RP8048



SPECIFICATION

HOPPER CAPACITY	1000 ML
AIR CONSUMPTION	170 L/MIN
WORKING PRESSURE	6-8 BAR
AIR INLET	1/4"
BARCODE	5056485704136

4x Nozzles (Surface nozzle, point nozzle, outer edge nozzle, inner edge nozzle), Blasting agent, Collecting bag

 **1/4"**
AIR INLET SIZE

 **6-8 BAR**
WORKING PRESSURE

 **1000ml**
HOPPER CAPACITY

ACCESSORIES INCLUDED

LASER & LEVELERS.

DISCOVER ACCURACY LIKE NEVER BEFORE WITH JCB'S LASER DISTANCE METERS AND CROSS LINE LASERS. JCB LASER DISTANCE METERS ARE DESIGNED TO DELIVER PRECISE MEASUREMENTS IN SECONDS, MAKING THEM AN INDISPENSABLE TOOL FOR ANY PROFESSIONAL. AND WHEN IT COMES TO LEVELING AND ALIGNMENT, OUR RED AND GREEN CROSS LINE LASERS WITH CLEAR, BRIGHT LINES FOR MAXIMUM VISIBILITY AND EASY-TO-USE CONTROLS, THEY ENSURE YOUR WORK IS ALWAYS PERFECTLY ALIGNED.

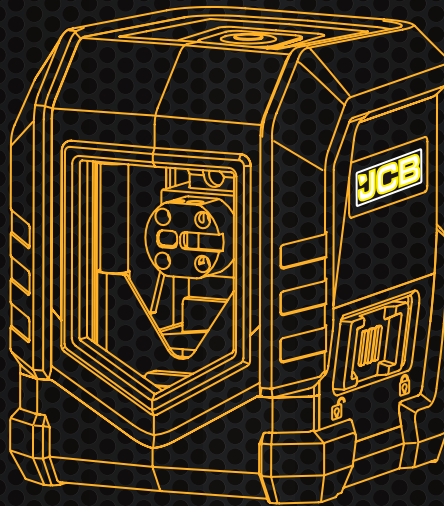
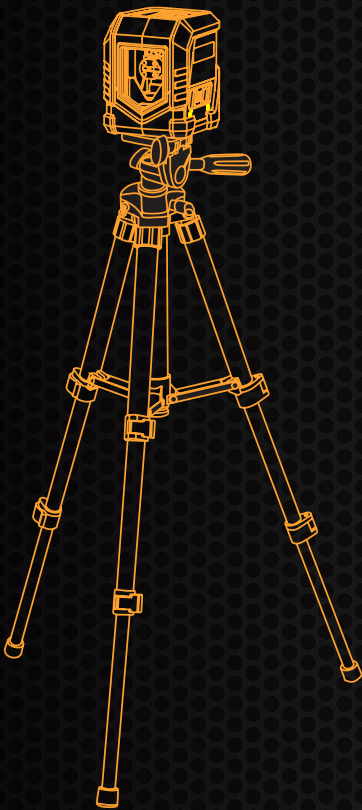

	JCB-LDM-30	JCB-LDM-65	JCB-LDM-65	JCB-CCL-G	JCB-CCL-R
					
MEASURING DISTANCE	0.05-30M	0.05-65M	0.05-80M	20M	0.05-80M
ACCURACY	±3MM	±3MM	±3MM	±8MM@10M	±3MM
LEVELING RANGE				±4 DEGREE	±4 DEGREE

30M LASER DISTANCE MEASURE

JCB-LDM-30



SPECIFICATION

MEASURING DISTANCE	0.05-30M
ACCURACY	±3MM
BARCODE	5056485704730

2XAAA RAYMAX ALKALINE BATTERIES INCLUDED.
 DISTANCE RANGE – MEASURES UP TO 30M/100FT.
 AUTOMATIC AREA AND VOLUME CALCULATIONS

FEATURES

- Multi function measure distance, area, volume, pythagoras(2-Point/3-Point) measure, continuous measurement, addition and subtraction, reference change the reference, unit setting
- Inverted backlit LCD display improves readability
- Ergonomic soft grip prevents tool from easy drop, bump

8

FUNCTIONS

30m



DISTANCE

±3mm



ACCURACY



FRONT / BACK

AAA
x2

INCLUDED

65M LASER DISTANCE MEASURE

JCB-LDM-65



SPECIFICATION

MEASURING DISTANCE	0.05-65M
ACCURACY	±3MM
BARCODE	5056485704747

2XAAA RAYMAX ALKALINE BATTERIES INCLUDED
 DISTANCE RANGE – MEASURES UP TO 65M.

FEATURES

- Multi function measure: single and continuous distance measure, area, volume, pythagoras (2-Point/3-Point) measure, min &max, addition and subtraction, reference change, unit setting.
- Back-lit LCD display improves readability.
- Three reference change, 30 measurement storage capability and beeper
- Functions make your measurements more convenient and efficient.
- Built-in bubble vial enables a visual reference for horizontal alignment.

8

FUNCTIONS

65m



DISTANCE

±3mm



ACCURACY



FRONT / BACK /
EXTENSION

AAA
x2

INCLUDED

x100

STORAGE
CAPACITY

80M RECHARGEABLE LASER DISTANCE MEASURE

JCB-LDM-65



SPECIFICATION

MEASURING DISTANCE	0.05-80M
ACCURACY	±3MM
BARCODE	5056485704754

RECHARGEABLE LI-ION BATTERY WITH USB-C CHARGING
DISTANCE RANGE – MEASURES UP TO 80M.

FEATURES

- Multi function measure: distance, area, volume, Pythagoras (2-Point/3-Point) measure, continuous measurement, min & max, addition and subtraction, reference change, unit setting.
- 30 data stored memory and beeper functions make your measurement more convenient and efficient.
- Built-in bubble vial enables a visual reference for horizontal alignment.
- Three reference changes make it easy for you to take measurements in different scenarios.
- In accordance with IEC60825-1

8

FUNCTIONS

80m



DISTANCE

±3mm



ACCURACY



FRONT / MIDDLE /
BACK

LI-ION

RECHARGEABLE



STORAGE
CAPACITY

GREEN BEAM SELF-LEVELING CROSS LINE LASER LEVEL

JCB-CCL-G



SPECIFICATION

MEASURING DISTANCE	20M
ACCURACY	±8MM@10M
LEVELING RANGE	±4 DEGREE
BARCODE	5056485704778

0.65M THREE-LEGGED SUPPORT INCLUDED
2XAA RAYMAX ALKALINE BATTERIES INCLUDED

FEATURES

- Self Leveling: projects two bright lines (horizontal & vertical) onto flat surfaces and levels in few seconds.
- One-button operation: easily switch the laser lines and turn it on and off.
- Can be wall or tripod mounted for quick and easy setup with M6 screw.
- Smart Pendulum System — Self-levels and indicates outof-level condition; locks when switched off
- Manual Mode — Locks lines for use at any angle

20m



DISTANCE

±0.8mm/m



ACCURACY

4°



SELF-LEVELING



INCLUDED



TRIPOD INCLUDED

RED BEAM SELF-LEVELING CROSS LINE LASER LEVEL

JCB-CCL-R



SPECIFICATION

MEASURING DISTANCE	0.05-80M
ACCURACY	±3MM
LEVELING RANGE	±4 DEGREE
BARCODE	5056485704761

0.65M THREE-LEGGED SUPPORT INCLUDED
2XAA RAYMAX ALKALINE BATTERIES INCLUDED

FEATURES

- Self Leveling: projects two bright lines (horizontal & vertical) onto flat surfaces and levels in few seconds.
- One-button operation: easily switch the laser lines and turn it on and off.
- Can be wall or tripod mounted for quick and easy setup with M6 screw.
- Smart Pendulum System — Self-levels and indicates outof-level condition; locks when switched off
- Manual Mode — Locks lines for use at any angle
- In accordance with IEC60825-1

10m



DISTANCE

±0.8mm/m



ACCURACY

4°



SELF-LEVELING



INCLUDED



TRIPOD INCLUDED

SOCKETS

EACH JCB SOCKET SET IS METICULOUSLY DESIGNED TO CATER TO A WIDE RANGE OF APPLICATIONS, OFFERING A COMPREHENSIVE SELECTION OF HIGH-QUALITY SOCKETS THAT MEET YOUR EVERY NEED. CRAFTED FROM DURABLE MATERIALS, OUR SOCKETS ARE BUILT TO WITHSTAND THE TOUGHEST WORKING CONDITIONS AND DELIVER OUTSTANDING PERFORMANCE OVER TIME.

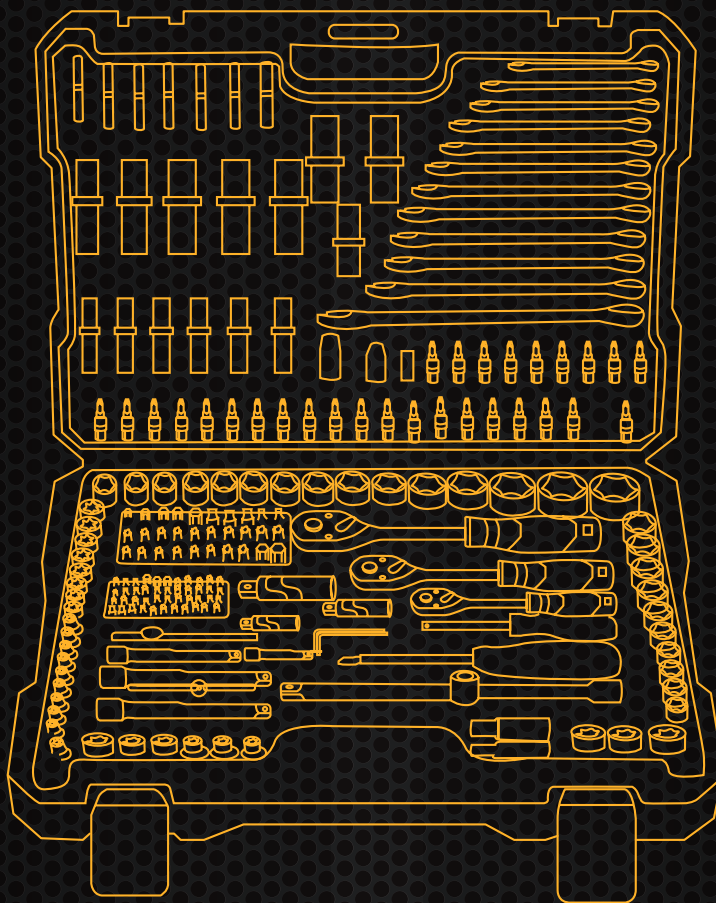

	JCB-3884I	JCB-41082-5	JCB-4941-5	JCB-4821-5
				
PIECE	216	108	94	82
DRIVE	1/4" & 3/8" & 1/2"	1/4" & 1/2"	1/4" & 1/2"	1/4" & 1/2"

216 PIECE SOCKET AND BIT SET

JCB-38841



216
PIECE



Cr-V
STEEL

1/2"
DRIVE

1/4"
DRIVE

3/8"
DRIVE



72 TOOTH



CASE INCLUDED

SPECIFICATION

BARCODE 5056485704082

1/4" DR. PART:

- 13 PIECE SOCKET: 4, 4.5, 5, 5.5, 6, 7, 8, 9, 10, 11, 12, 13, 14 MM
- 5 PIECE TORX SOCKET: E4, E5, E6, E7, E8 MM
- 7 PIECE DEEP SOCKET: 4.5, 6, 7, 8, 9, 10MM
- 1 PIECE SLIDING T BAR
- 2 PIECE EXTENSION BAR: 2" ,4"
- 1 PIECE BIT HOLDER
- 1 PIECE UNIVERSAL JOINT
- 1 PIECE SPINNER HANDLE 6"
- 1 PIECE QUICK RATCHET HANDLE

3/8" DR. PART:

- 10 PIECE SOCKET: 10, 11, 12, 13, 14, 15, 16, 17, 18, 19 MM
- 6 PIECE TORX SOCKET: E10, E11, E12, E14, E16, E18
- 6 PIECE DEEP SOCKET: 10, 11, 12, 13, 14, 15MM
- 1 PIECE SPARK PLUG SOCKET 18MM
- 1 PIECE BIT HOLDER
- 1 PIECE UNIVERSAL JOINT
- 1 PIECE EXTENSION BAR 5"
- 1 PIECE QUICK RATCHET HANDLE

1/2 DR. PART:

- 15 PIECE SOCKET: 10, 11, 12, 13, 14, 15, 17, 19, 20, 21, 22, 24, 27, 30, 32MM
- 3 PIECE TORX SOCKET: E20, E22, E24
- 5 PIECE DEEP SOCKET: 16, 17, 18, 19, 22MM
- 2 PIECE EXTENSION BAR: 5" 10"
- 1 PIECE 3-WAY ADAPTER
- 1 PIECE UNIVERSAL JOINT
- 1 PIECE BIT HOLDER
- 2 PIECE SPARK PLUG SOCKET: 16, 21MM
- 1 PIECE QUICK RATCHET HANDLE

- 2 PIECE BIT SOCKET: T55, T60

- 12 PIECE -SPANNER: 8, 10, 11, 12, 13, 14, 15, 16, 17, 18, 19, 22MM

- 7 PIECE -HEX KEY WRENCH: 1.27, 1.5, 2, 2.5, 3, 4, 5MM

30 PIECE BIT SOCKET:

- PH: 3, 4; PZ: 3, 4; FD: 6, 6.5, 7, 8MM
- HEX: 5, 5.5, 6, 6.5, 7, 8MM; TORX: 25, 27, 30, 35, 40, 40, 45, 50
- TT: 27, 30, 35, 40, 45, 50; M: 5, 6, 8, 10

30 PIECE -BIT:

- HEX: 5, 5.5, 6, 6.5, 7, 8MM; SL: 6, 6.5, 8MM; PH: 3, 4; PZ: 3, 4
- TORX: 25, 27, 30, 35, 40, 40, 45, 50; TT: 27, 30, 35, 40, 45, 50
- M: 5, 6, 8, 10

44 PIECE -BIT:

- SL: 4, 5.5, 6.5MM; PH: 1, 2; PZ: 1; TORX: 8, 10, 15, 20, 25
- TT: 8, 10, 10, 15, 15, 20, 20, 25, 25, 40; HEX: 3, 4, 5, 6
- H WITH HOLE: 3, 4, 5, 6; M: 5, 6, 8; S: 1, 2; Y: 1, 2, 3; TORQ: 6, 8, 10
- SPANNER: 4, 6, 8

- 1 PIECE SCREWDRIVER

- 1 PIECE BLOW CASE WITH LOGO + COLOUR SLEEVE

108 PIECE SOCKET AND BIT SET

JCB-41082-5



SPECIFICATION

BARCODE	5056485704112
---------	---------------

1/4" DR PART:

- 13 PIECE SOCKET: 4, 4.5, 5, 5.5, 6, 7, 8, 9, 10, 11, 12, 13, 14 MM
- 8 PIECE DEEP SOCKET: 6, 7, 8, 9, 10, 11, 12, 13MM
- 5 PIECE TORX SOCKET: E4, E5, E6, E7, E8 MM
- 2 PIECE EXTENSION BAR: 2", 4"
- 1 PIECE UNIVERSAL JOINT
- 1 PIECE QUICK RATCHET HANDLE
- 1 PIECE SLIDING T BAR
- 1 PIECE SPINNER HANDLE 6"

1/2" DR. PART:

- 17 PIECE SOCKET: 10, 11, 12, 13, 14, 15, 16, 17, 18, 19, 20, 21, 24, 27, 30, 32 MM
- 5 PIECE DEEP SOCKET : 14, 15, 17, 19, 22 MM
- 2 PIECE SPARK PLUG SOCKET 16, 21MM
- 8 PIECE TORX SOCKET: 10, 11, 12, 14, 16, 18, 20, 24 MM
- 2 PIECE EXTENSION BAR: 5" 10"
- 1 PIECE UNIVERSAL JOINT
- 1 PIECE QUICK RATCHET HANDLE
- 1 PIECE BIT ADAPTOR
- 1 PIECE 3-WAY ADAPTOR

18 PIECE -BIT SOCKET

- SL: 4, 5.5, 6.5MM
- PH: 1, 2
- PZ: 1, 2
- HEX: 3, 4, 5, 6MM
- TORX: 8, 10, 15, 20, 25, 27, 30

17 PIECE BIT:

- SL: 8, 10, 12MM
- PH: 3, 4
- PZ: 3, 4
- HEX: 7, 8, 10, 12, 14MM
- TORX: 40, 45, 50, 55, 60

3 PIECE -HEX KEY WRENCH: 1.5, 2, 2.5MM

- 1 PIECE BLOW CASE WITH LOGO + COLOUR SLEEVE

108
PIECE



Cr-V
STEEL

1/2"
DRIVE

1/4"
DRIVE



72 TOOTH



CASE INCLUDED

94 PIECE SOCKET AND BIT SET

JCB-4941-5



SPECIFICATION

BARCODE	5056485704105
---------	---------------

- 1/4" DR PART:
- 13 PIECE SOCKET 4,4.5, 5, 5.5, 6,7,8,9,10,11,12, 13, 14MM
 - 8 PIECE DEEP SOCKET: 6, 7, 8, 9, 10, 11, 12, 13MM
 - 1 PIECE ADAPTOR
 - 1 PIECE UNIVERSAL JOINT
 - 1 PIECE QUICK RATCHET HANDLE
 - 1 PIECE DR SPINNER HANDLE 6"
 - 1 PIECE FLEXIBLE EXTENSION 2", 4"
 - 1 PIECE SLIDING T BAR
- 1/2" DR. PART:
- 18 PIECE SOCKET 10, 11,12, 13, 14, 15, 16, 17, 18, 19, 20, 21, 22, 23, 24, 27, 30, 32MM
 - 4 PIECE DEEP SOCKET 14, 15, 17, 19MM
 - 2 PIECE SPARK PLUG SOCKET 16, 21MM
 - 1 PIECE BIT ADAPTOR
 - 2 PIECE EXTENSION BAR 5" 10"
 - 1 PIECE UNIVERSAL JOINT
 - 1 PIECE QUICK RATCHET HANDLE
 - 1 PIECE 3-WAY ADAPTOR
- 17 PIECE BIT SOCKET:
- SL: 4, 5.5, 7MM
 - PH: 1, 2
 - PZ: 1, 2
 - HEX: 3, 4,5, 6MM
 - TORX: 8, 10, 15, 20, 25, 30
- 15 PIECE BIT:
- SL: 8 10, 12MM
 - PH: 3,4
 - PZ: 3, 4
 - HEX: 8, 10, 12, 14MM
 - TORX: 40, 45, 50, 55
- 3 PIECE HEX KEY WRENCH: 1.5, 2, 2.5MM
 - 1 PIECE BLOW CASE WITH LOGO + COLOUR SLEEVE

94
PIECE



Cr-V
STEEL

1/2"
DRIVE

1/4"
DRIVE



CASE INCLUDED

82 PIECE SOCKET AND BIT SET

JCB-4821-5



SPECIFICATION

BARCODE	5056485704099
---------	---------------

1/4" DR PART:

- 13 PIECE SOCKET 4,4.5, 5, 5.5, 6,7,8,9,10,11,12, 13, 14MM
- 2 PIECE EXTENSION BAR 2", 4"
- 1 PIECE FLEXIBLE EXTENSION 6"
- 1 PIECE UNIVERSAL JOINT
- 1 PIECE SPINNER HANDLE 6"
- 1 PIECE SLIDING T BAR
- 1 PIECE QUICK RATCHET HANDLE
- 1 PIECE ADAPTOR

1/2" DR. PART:

- 12 PIECE SOCKET 14, 15, 16, 17, 18, 19, 20, 22, 24, 27, 30, 32MM
- 2 PIECE EXTENSION BAR 5", 10"
- 2 PIECE SPARK PLUG SOCKET 16, 21MM
- 1 PIECE 3-WAY ADAPTOR: 3/8" (F) X 1/2" (M)
- 1 PIECE UNIVERSAL JOINT
- 1 PIECE QUICK RATCHET HANDLE
- 1 PIECE BIT HOLDER
- 9 PIECE SPANNER 8, 10, 11,12,13,14, 17, 19, 22MM

17 PIECE BIT SOCKET:

- SL: 4, 5.5, 7MM
- PH: 1, 2
- PZ: 1, 2
- HEX 3,4,5,6MM
- TORX: 8, 10, 15, 20, 25, 30

15 PIECE BIT:

- SL: 8 10, 12MM
- PH 3,4
- PZ 3,4
- HEX 8, 10, 12, 14MM
- TORX 40, 45, 50, 55

- 1 PIECE BLOW CASE WITH LOGO + COLOUR SLEEVE

82

PIECE



Cr-V

STEEL

1/2"

DRIVE

1/4"

DRIVE



72 TOOTH



CASE INCLUDED

SPANNERS

JCB SPANNERS ENGINEERED FROM HIGH-GRADE MATERIALS, OUR SPANNERS RESIST WEAR AND TEAR, PROMISING A LONG LIFESPAN EVEN IN THE MOST CHALLENGING CONDITIONS. THEIR ERGONOMIC DESIGN ENSURES A COMFORTABLE GRIP, REDUCING USER FATIGUE AND ENHANCING EFFICIENCY.

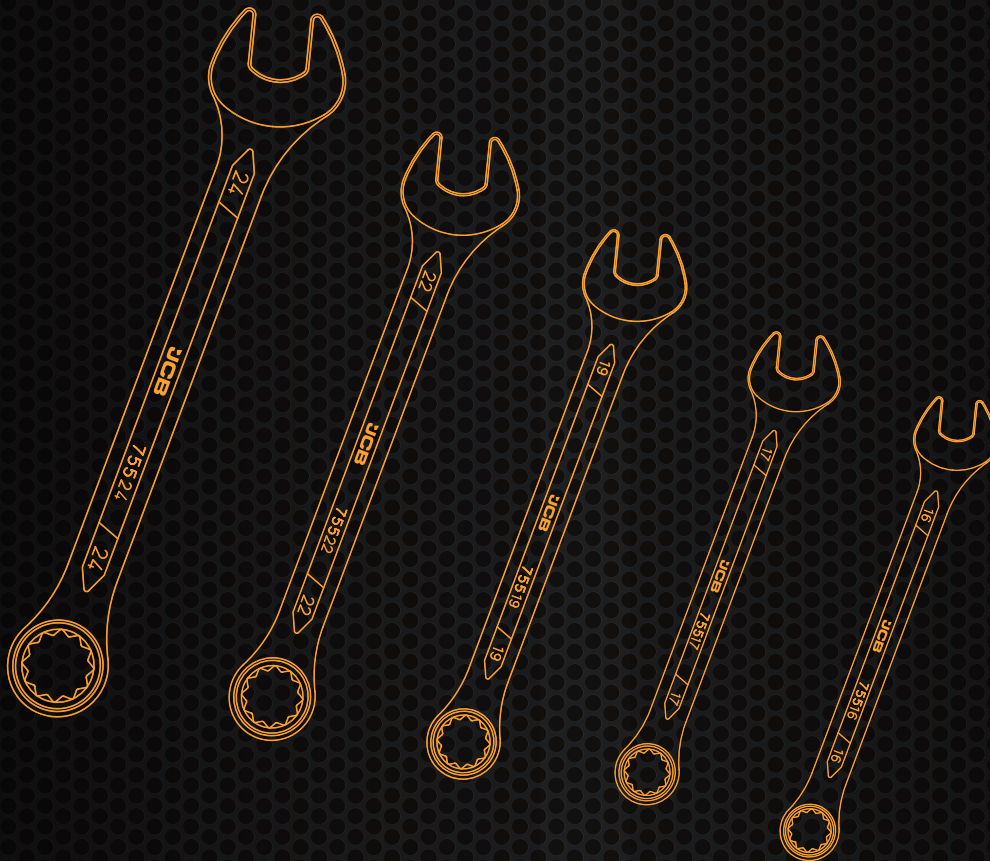

	JCB-5121P	JCB-5141P	JCB-5161P	JCB-5181P	JCB-5261P	JCB-5261P36
PIECE	12	14	16	18	25	25
DRIVE	8, 10, 11, 12, 13, 14, 15, 16, 17, 19, 22, 24 MM	10, 12, 13, 14, 15, 16, 17, 18, 19, 21, 24, 27, 30, 32 MM	6, 7, 8, 9, 10, 11, 12, 13, 14, 15, 16, 17, 18, 19, 22, 24 MM	8, 9, 10, 11, 12, 13, 14, 15, 16, 17, 18, 19, 21, 22, 24, 27, 30, 32 MM	6, 7, 8, 9, 10, 11, 12, 13, 14, 15, 16, 17, 18, 19, 20, 21, 22, 23, 24, 25, 26, 27, 28, 30, 32 MM	6, 7, 8, 9, 10, 11, 12, 13, 14, 15, 16, 17, 18, 19, 20, 21, 22, 23, 24, 25, 27, 28, 30, 32, 36 MM

12 PIECE COMBINATION SPANNER SET

JCB-5121P



SPECIFICATION

8, 10, 11, 12, 13, 14, 15, 16, 17, 19, 22, 24 MM

BARCODE

5056485704013



8 / 10 / 11 / 12 / 13 / 14 / 15 /
16 / 17 / 19 / 22 / 24 mm

Cr-V
STEEL

CASE
INCLUDED



14 PIECE COMBINATION SPANNER SET

JCB-5141P



SPECIFICATION

10, 12, 13, 14, 15, 16, 17, 18, 19, 21, 24, 27, 30, 32 MM

BARCODE

5056485704044



10 / 12 / 13 / 14 / 15 / 16 / 17 / 18 /
19 / 21 / 24 / 27 / 30 / 32 mm

Cr-V
STEEL

CASE
INCLUDED



16 PIECE COMBINATION SPANNER SET

JCB-5161P



SPECIFICATION

6, 7, 8, 9, 10, 11, 12, 13, 14, 15, 16, 17, 18, 19, 22, 24 MM

BARCODE

5056485704020



6 / 7 / 8 / 9 / 10 / 11 / 12 / 13 / 14 /
15 / 16 / 17 / 18 / 19 / 22 / 24 mm

Cr-V
STEEL

CASE
INCLUDED

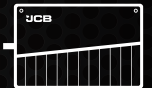

18 PIECE COMBINATION SPANNER SET

JCB- 5181P



SPECIFICATION

8, 9, 10, 11, 12, 13, 14, 15, 16, 17, 18, 19, 21, 22, 24, 27, 30, 32 MM

BARCODE

5056485704015



8 / 9 / 10 / 11 / 12 / 13 / 14 / 15 / 16 / 17 /
18 / 19 / 21 / 22 / 24 / 27 / 30 / 32 mm

Cr-V
STEEL

CASE
INCLUDED



25 PIECE COMBINATION SPANNER SET

JCB-5261P



SPECIFICATION

6-32MM

BARCODE

5056485704068



6 / 7 / 8 / 9 / 10 / 11 / 12 / 13 / 14 / 15 /
16 / 17 / 18 / 19 / 20 / 21 / 22 / 23 /
24 / 25 / 26 / 27 / 28 / 30 / 32 mm

Cr-V
STEEL

CASE
INCLUDED



25 PIECE COMBINATION SPANNER SET

JCB-5261P36



SPECIFICATION

6-25, 27, 28, 30, 32, 36 MM

BARCODE

5056485704075



6 / 7 / 8 / 9 / 10 / 11 / 12 / 13 / 14 / 15
/ 16 / 17 / 18 / 19 / 20 / 21 / 22 / 23
/ 24 / 25 / 27 / 28 / 30 / 32 / 36 mm

Cr-V
STEEL

CASE
INCLUDED



COMBINATION SPANNERS



SPECIFICATION

JCB-75506	6MM COMBINATION SPANNER	6mm
JCB-75507	7MM COMBINATION SPANNER	7mm
JCB-75508	8MM COMBINATION SPANNER	8mm
JCB-75509	9MM COMBINATION SPANNER	9mm
JCB-75510	10MM COMBINATION SPANNER	10mm
JCB-75511	11MM COMBINATION SPANNER	11mm
JCB-75512	12MM COMBINATION SPANNER	12mm
JCB-75513	13MM COMBINATION SPANNER	13mm
JCB-75514	14MM COMBINATION SPANNER	14mm
JCB-75515	15MM COMBINATION SPANNER	15mm
JCB-75516	16MM COMBINATION SPANNER	16mm
JCB-75517	17MM COMBINATION SPANNER	17mm
JCB-75518	18MM COMBINATION SPANNER	18mm
JCB-75519	19MM COMBINATION SPANNER	19mm
JCB-75520	20MM COMBINATION SPANNER	20mm
JCB-75521	21MM COMBINATION SPANNER	21mm
JCB-75523	23MM COMBINATION SPANNER	23mm
JCB-75524	24MM COMBINATION SPANNER	24mm
JCB-75525	25MM COMBINATION SPANNER	25mm
JCB-75526	26MM COMBINATION SPANNER	26mm
JCB-75527	27MM COMBINATION SPANNER	27mm
JCB-75528	28MM COMBINATION SPANNER	28mm
JCB-75529	29MM COMBINATION SPANNER	29mm
JCB-75530	30MM COMBINATION SPANNER	30mm
JCB-75532	32MM COMBINATION SPANNER	32mm

Cr-V
STEEL



REGIONAL OFFICES

Poland

Trade House Forsage Instrument Pol Sp. Z. O.O.
VAT UE: PL5423283539
ul. Św. Proroka Eliasza 8, 15-568 Białystok, POLSKA
Tel: 48 723 622 021
<https://jcbtools.eu/>

Hong Kong

Forsage International Ltd.
D2, 16th Floor, TML Tower, no. 3 Hoi Shing Road,
Tsuen Wan, NT, Hong Kong
Tel.: +852 6389 5977

Dubai

27 20th St - Al Khabaisi
Dubai - United Arab Emirates
Tel: +971 524341734
<https://rockforce.ae/>

Azerbaijan

FORSAGE CAUCASUS" LLC
Azerbaijan, Baku , Babek avenue,
Kamran Afbari 37B
GSM: +994 702005066
www.forsage.az

Lithuania

UAB "Fagih Baltic"
tel./fax: +370 5 2405006 Titnago G. 78
LT-02300 VILNIUS
www.irankiaiforce.lt

Georgia

LLC "Forsage Georgia"
st. Tsereteli R. Agladze No. 18, Tbilisi
Tel: 568447420
www.bt-ingenieros.com

Ukraine

"TH "Forsage-Instrument" LLC
04128, Ukraine, Kiev, Plodovaya St.1
Tel: +7 727 325 00 77

Kazakhstan

Prime Tools LLP
202, Dostyk Ave., Almaty, Kazakhstan
Tel: +7 727 325 00 77
www.prime-tools.kz

Turkey

Forsage Turkey Ic ve Dis Tic. Ltd. Sti.
Alemdag cad. No:402A Ümraniye / Istanbul / Turkey
+90 216 210 19 01
www.forsageturkey.com.tr/

Uzbekistan

LLC "FORSAGE Tool Asia"
Uzgarish, st. Navruz 2a, Sergeli district Tashkent,
Uzbekistan
Tel: +998900181813
www.forsage-tool.uz



TRADE HOUSE